



cintas y especialidades  
impresas s.a. de c.v.

# CATALOGO DE SUAJES

## INDICE

GUIA PARA LA SELECCION DE SUAJES.....	Pag. 1
RECTANGULOS VERTICALES .....	Pag. 2 a la 5
CUADRADOS.....	Pag. 6
RECTANGULOS HORIZONTALES.....	Pag. 7 a la 23
CIRCULOS .....	Pag. 24
OVALOS .....	Pag. 25
FORMAS ESPECIALES.....	Pag. 26 a la 49
SUAJES DE CORTE COMPLETO Y CORTE ESPECIAL .....	Pag. 50 y 51

# GUIA PARA LA SELECCION DE SUAJES

## FORMA DEL SUAJE

**MEDIDA:** A= Medida en sentido longitudinal al rollo.

B= Medida en sentido transversal al rollo.

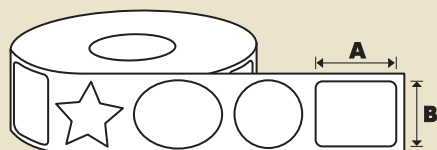

Fig. 1

108/54/2  
A= 40 mm  
B= 60 mm  
MAQUINAS= 7,8

Fig. 2

**MAQUINA:** Indica la(s) máquina(s) en la(s) que se puede utilizar el suaje. Revise la Fig. 3 para asegurarse que la combinación "SUAJE - MAQUINA" que selecciono se adecua a sus necesidades.

**NUMERO DE SUAJE:** Haga referencia a este número cuando seleccione el suaje.

## CAPACIDAD DEL EQUIPO DE IMPRESION

MAQUINA	NUMERO DE TINTAS MAXIMO	ACABADOS DISPONIBLES	TIPO DE IMPRESION	TIRAJE
3	6 ó 5 + BARNIZ	LAMINACION BARNIZ U.V. BARNIZ STD.	TINTAS DIRECTAS Y SELECCION DE COLOR	BAJO ó MEDIO
4	6 ó 5 + BARNIZ	LAMINACION BARNIZ U.V. BARNIZ STD.	TINTAS DIRECTAS Y SELECCION DE COLOR	BAJO ó MEDIO
7	7 ó 6 + BARNIZ	LAMINACION BARNIZ U.V. BARNIZ STD.	TINTAS DIRECTAS Y SELECCION DE COLOR	MEDIO ó ALTO
8	6 ó 5 + BARNIZ	LAMINACION BARNIZ U.V. BARNIZ STD.	TINTAS DIRECTAS Y SELECCION DE COLOR	MEDIO ó ALTO

Fig. 3

**PARA VER EL CATALOGO COMPLETO VEA LAS PAGINAS 2 A LA 49**

**NOTA:** Los suajes marcados con "\*" son de uso exclusivo y requieren autorización para su uso.



cintas y especialidades  
impresas s.a. de c.v.



**SUAJES RECTANGULOS VERTICALES**

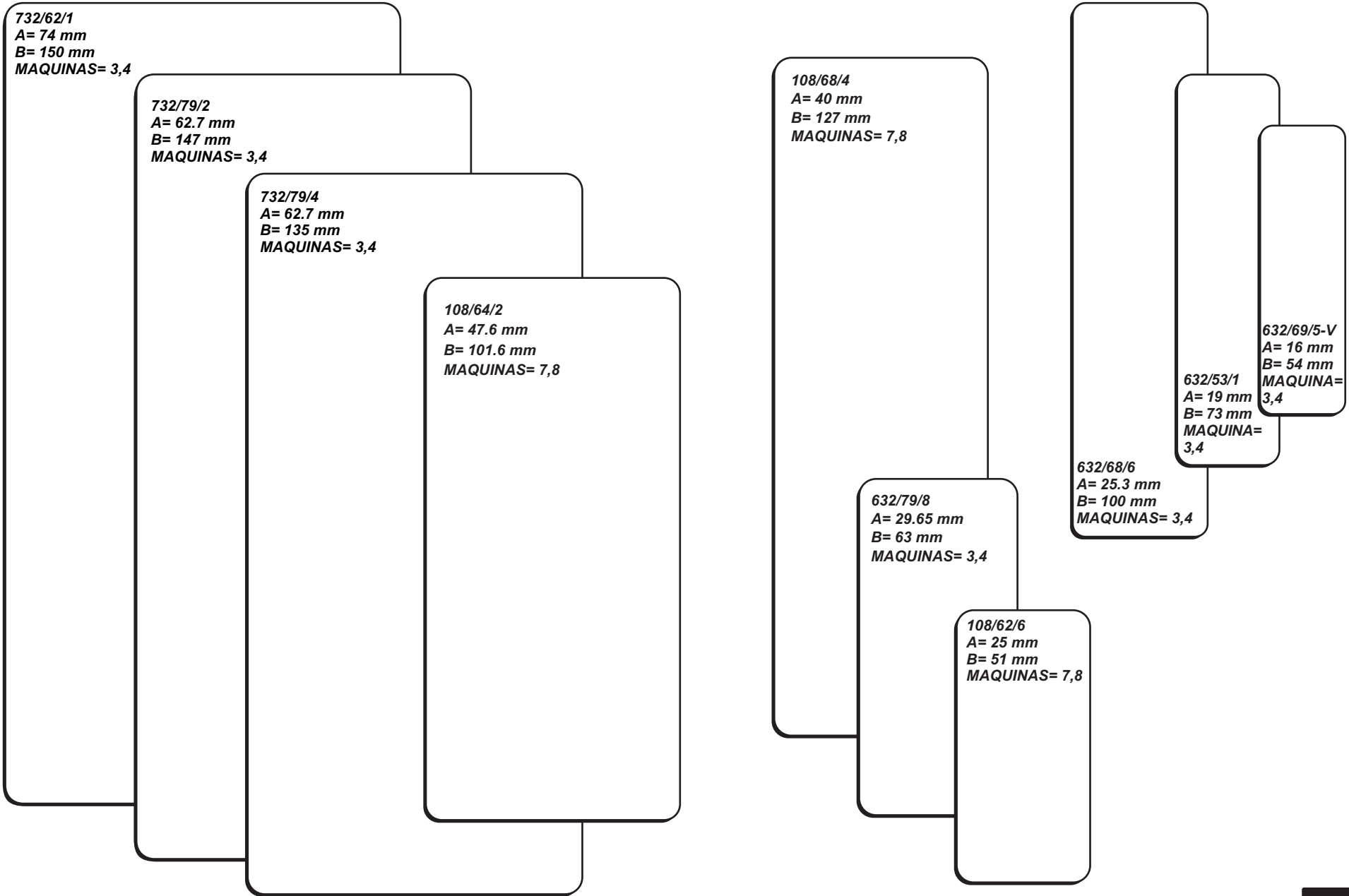



cintas y especialidades  
impresas s.a. de c.v.



**SUAJES RECTANGULOS VERTICALES**

108/84/6  
A= 85 mm  
B= 153 mm  
MAQUINAS= 7,8

632/79/10  
A= 62.5 mm  
B= 112 mm  
MAQUINAS= 3,4

632/114/1  
A= 67.9 mm  
B= 122 mm  
MAQUINAS= 3,4

632/57/3  
A= 25.4 mm  
B= 38.1 mm  
MAQUINAS= 3,4

108/74/3  
A= 55 mm  
B= 85 mm  
MAQUINAS= 7,8

108/54/2  
A=40 mm  
B= 60 mm  
MAQUINAS= 7,8



cintas y especialidades  
impresas s.a. de c.v.



**SUAJES RECTANGULOS VERTICALES**

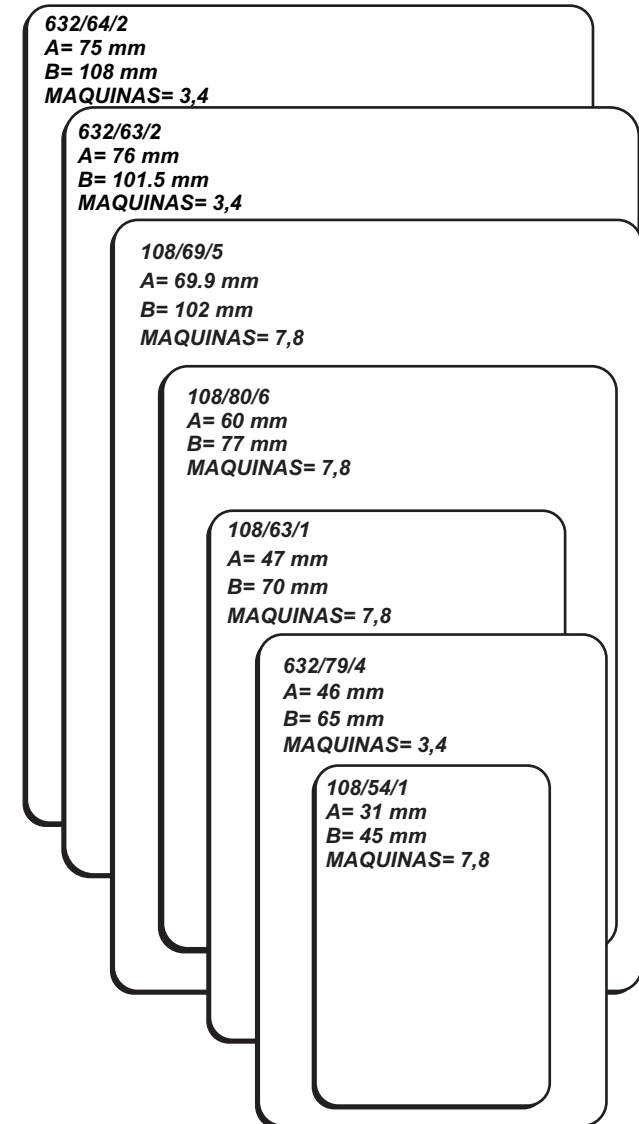
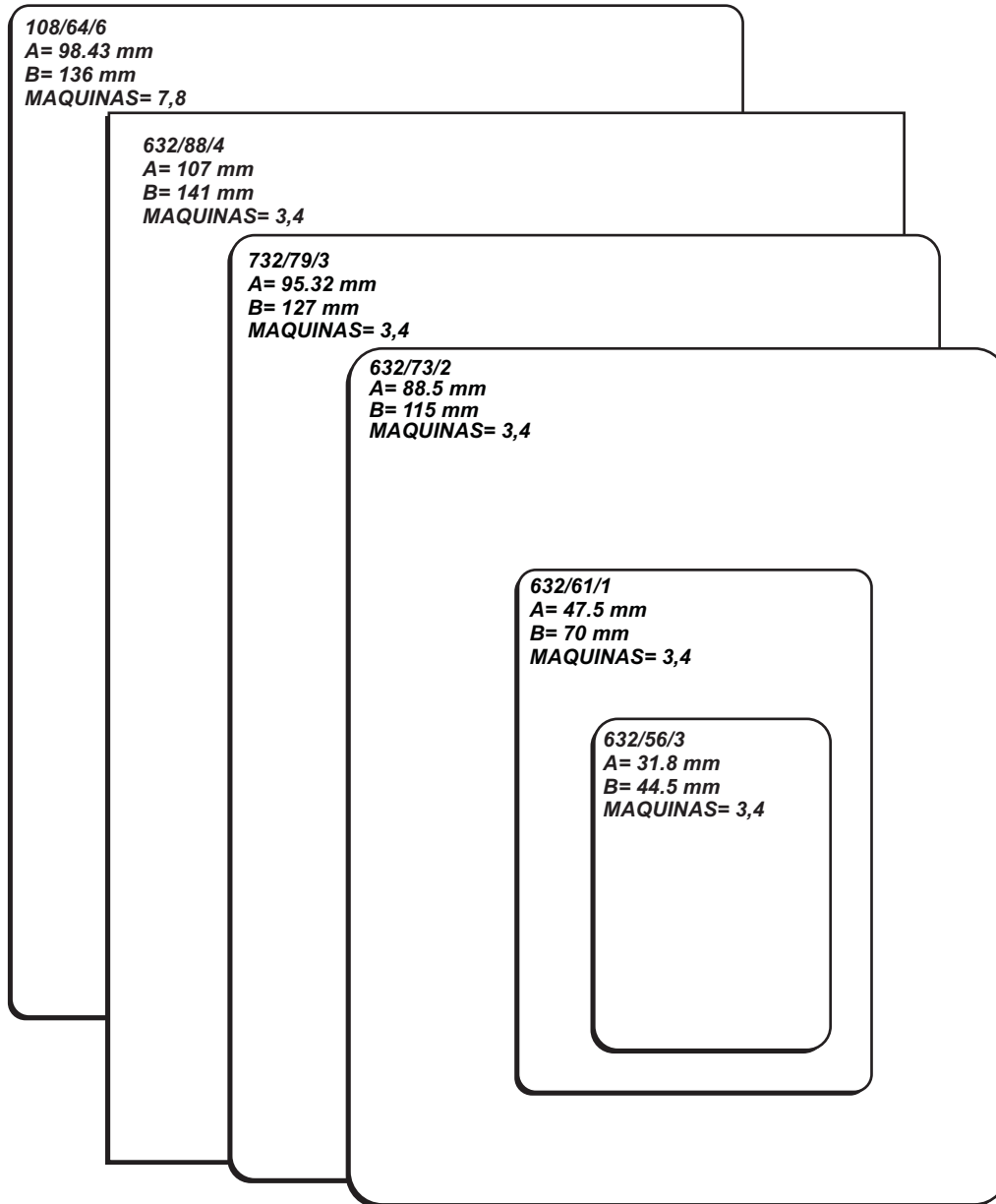



cintas y especialidades  
impresas s.a. de c.v.

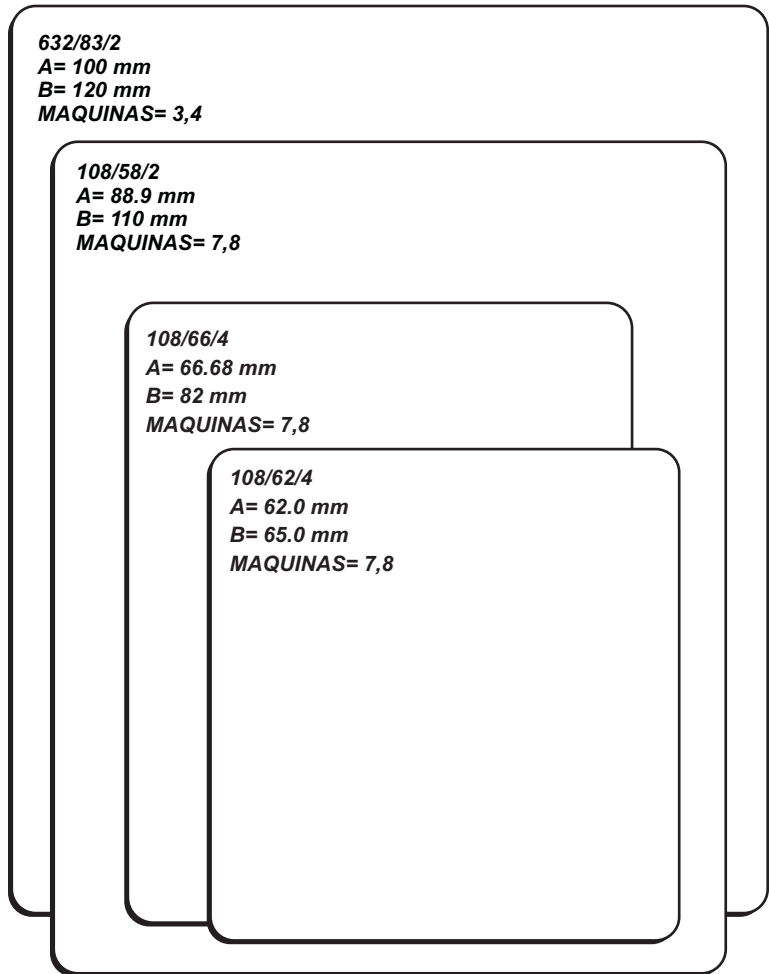
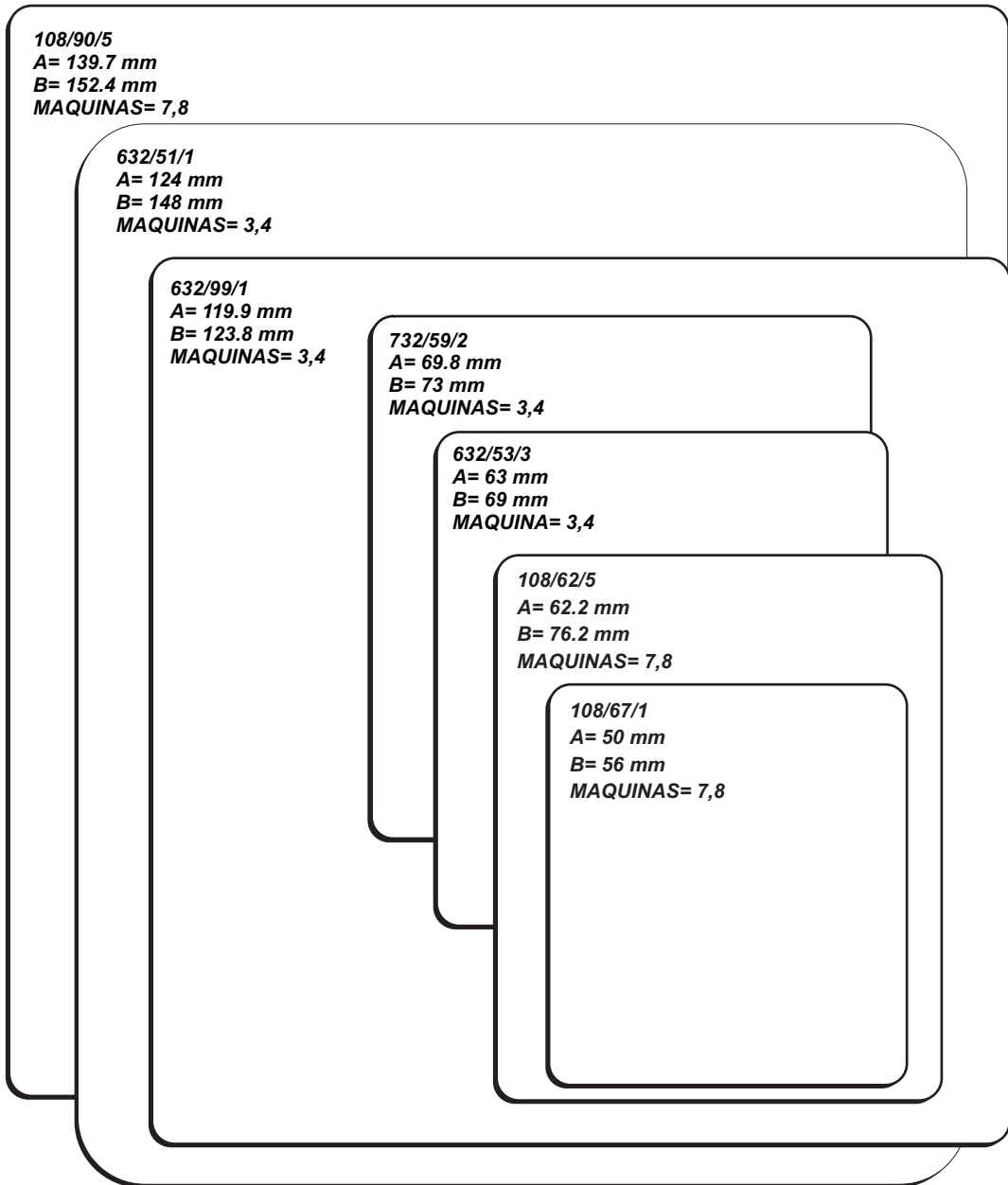



cintas y especialidades  
impresas s.a. de c.v.



**SUAJES CUADRADOS**

108/78/7  
A= 79.6 mm  
B= 79.6 mm  
MAQUINAS= 7,8

632/59/7  
A= 70 mm  
B= 70 mm  
MAQUINAS= 3,4

108/69/1  
A= 70 mm  
B= 70 mm  
MAQUINAS= 7,8

108/60/3  
A= 60 mm  
B= 60 mm  
MAQUINAS= 7,8

632/69/3  
A= 40 mm  
B= 40 mm  
MAQUINAS= 3,4

632/70/1  
A= 31.7 mm  
B= 31.7 mm  
MAQUINAS= 3,4

632/60/2  
A= 12 mm  
B= 12 mm  
MAQUINAS= 3,4



cintas y especialidades  
impresas s.a. de c.v.



**SUAJES RECTANGULOS HORIZONTALES**

732/65/1  
A= 159 mm  
B= 154 mm  
MAQUINAS= 3,4

632/57/4  
A= 67.7 mm  
B= 59.7 mm  
MAQUINAS= 3,4

108/88/2  
A= 90 mm  
B= 80 mm  
MAQUINAS= 7,8

108/65/1  
A= 100 mm  
B= 90 mm  
MAQUINAS= 7,8

108/68/2  
A= 50.8 mm  
B= 44 mm  
MAQUINAS= 7,8

632/71/2  
A= 56 mm  
B= 50 mm  
MAQUINAS= 3,4

108/67/5  
A= 67.63 mm  
B= 60 mm  
MAQUINAS= 7,8



cintas y especialidades  
impresas s.a. de c.v.



**SUAJES RECTANGULOS HORIZONTALES**

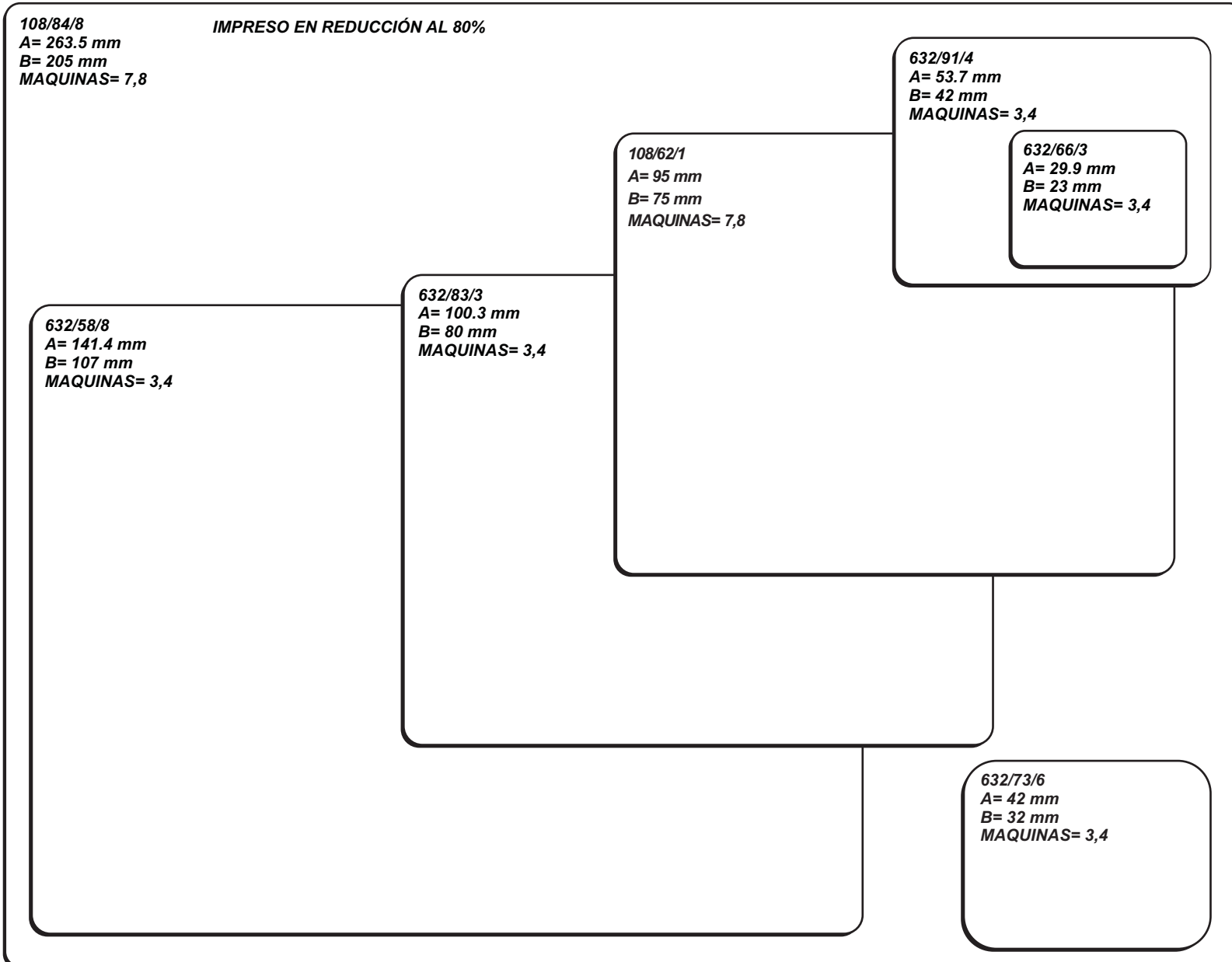

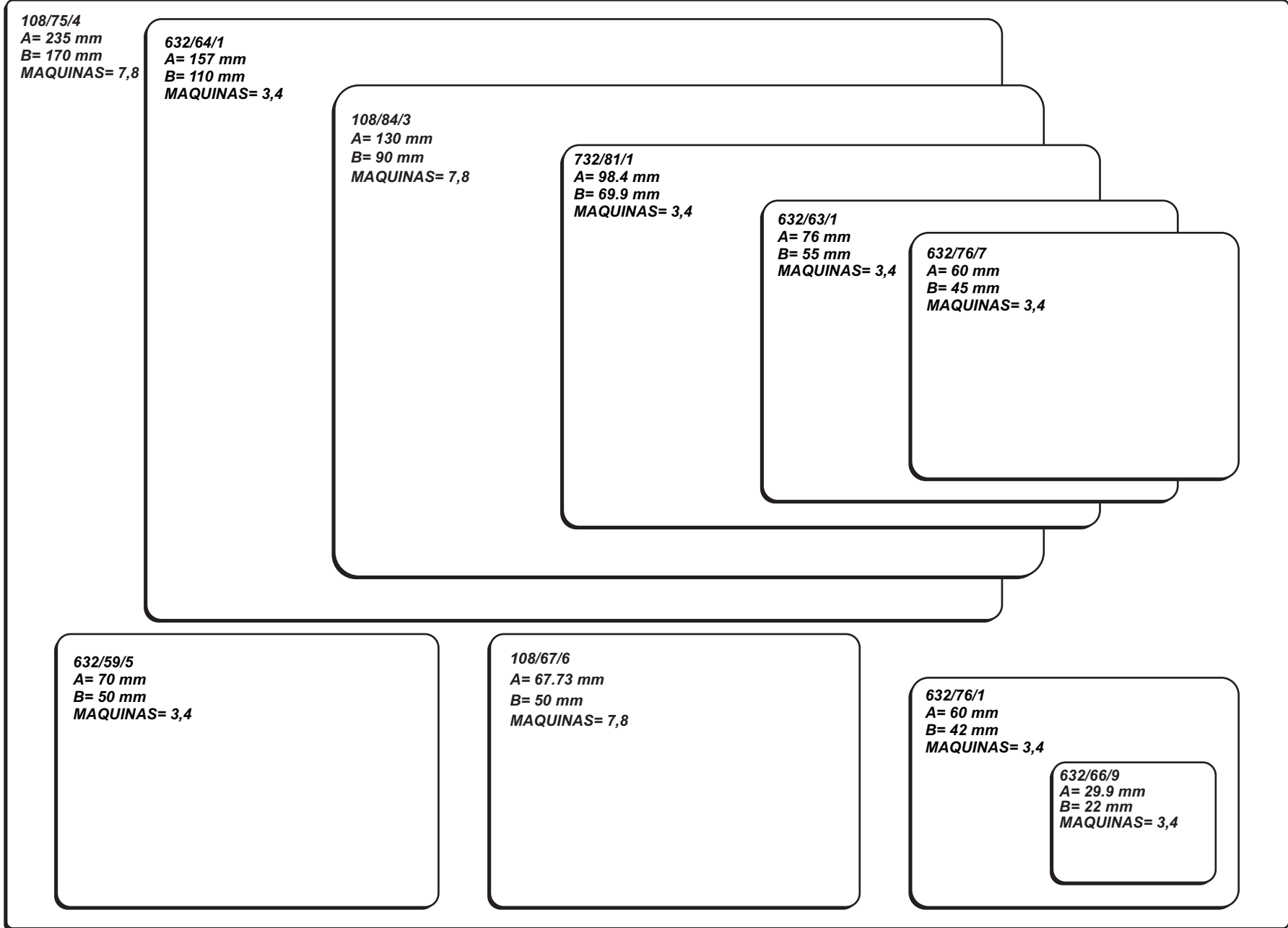



cintas y especialidades  
impresas s.a. de c.v.



**SUAJES RECTANGULOS HORIZONTALES**

632/79/5  
A= 193 mm  
B= 130 mm  
MAQUINAS= 3,4

732/62/2  
A= 151.4 mm  
B= 97 mm  
MAQUINAS= 3,4

108/84/4  
A= 130.2 mm  
B= 86.3 mm  
MAQUINAS= 7,8

732/94/1  
A= 114.3 mm  
B= 76.2 mm  
MAQUINAS= 3,4

732/74/1  
A= 88.9 mm  
B= 60.3 mm  
MAQUINAS= 3,4

732/59/1  
A= 69.9 mm  
B= 44.5 mm  
MAQUINAS= 3,4

632/61/5  
A= 47 mm  
B= 30 mm  
MAQUINAS= 3,4

632/66/2  
A= 38 mm  
B= 25 mm  
MAQUINAS= 3,4



cintas y especialidades  
impresas s.a. de c.v.



**SUAJES RECTANGULOS HORIZONTALES**

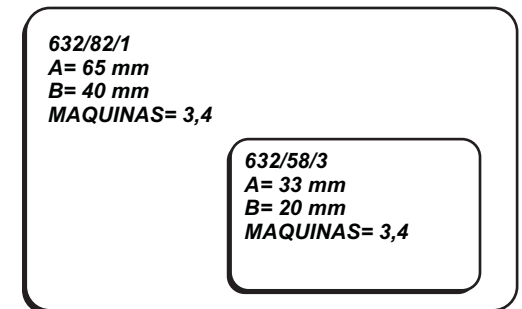
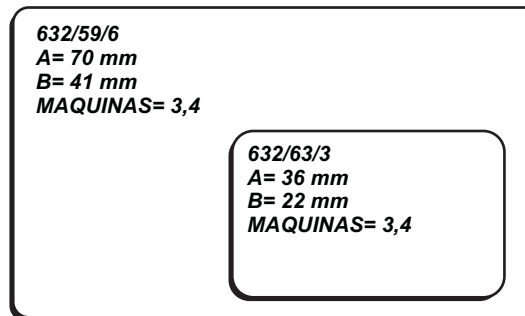
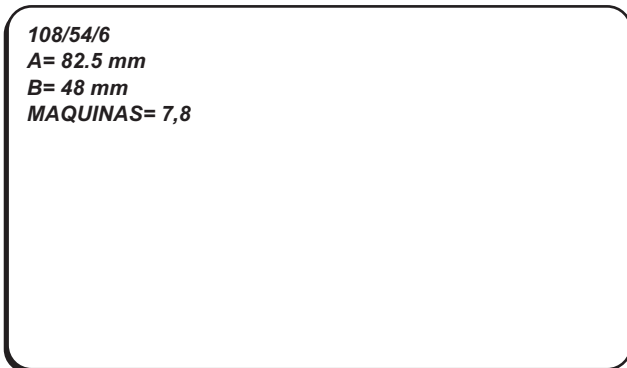
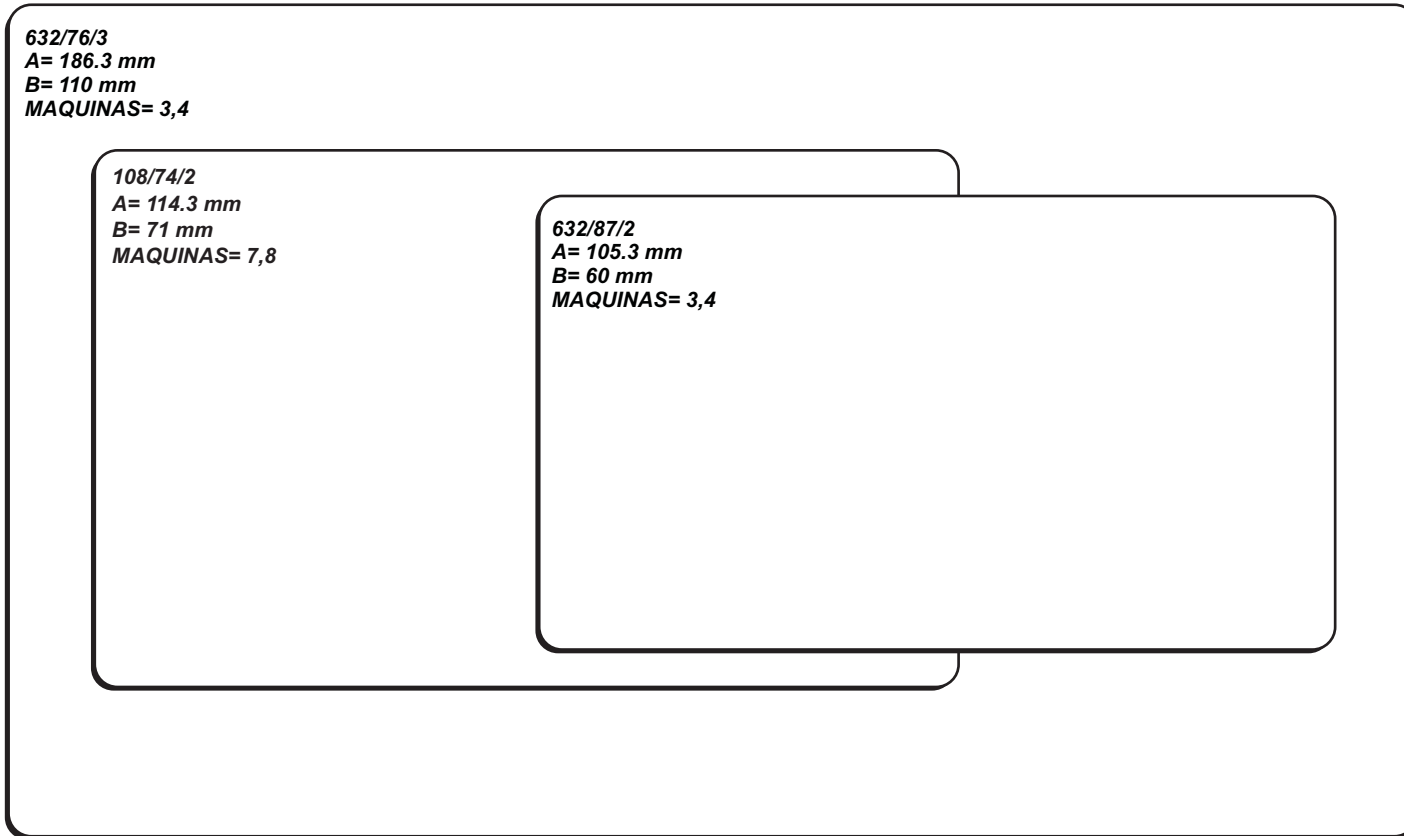



cintas y especialidades  
impresas s.a. de c.v.

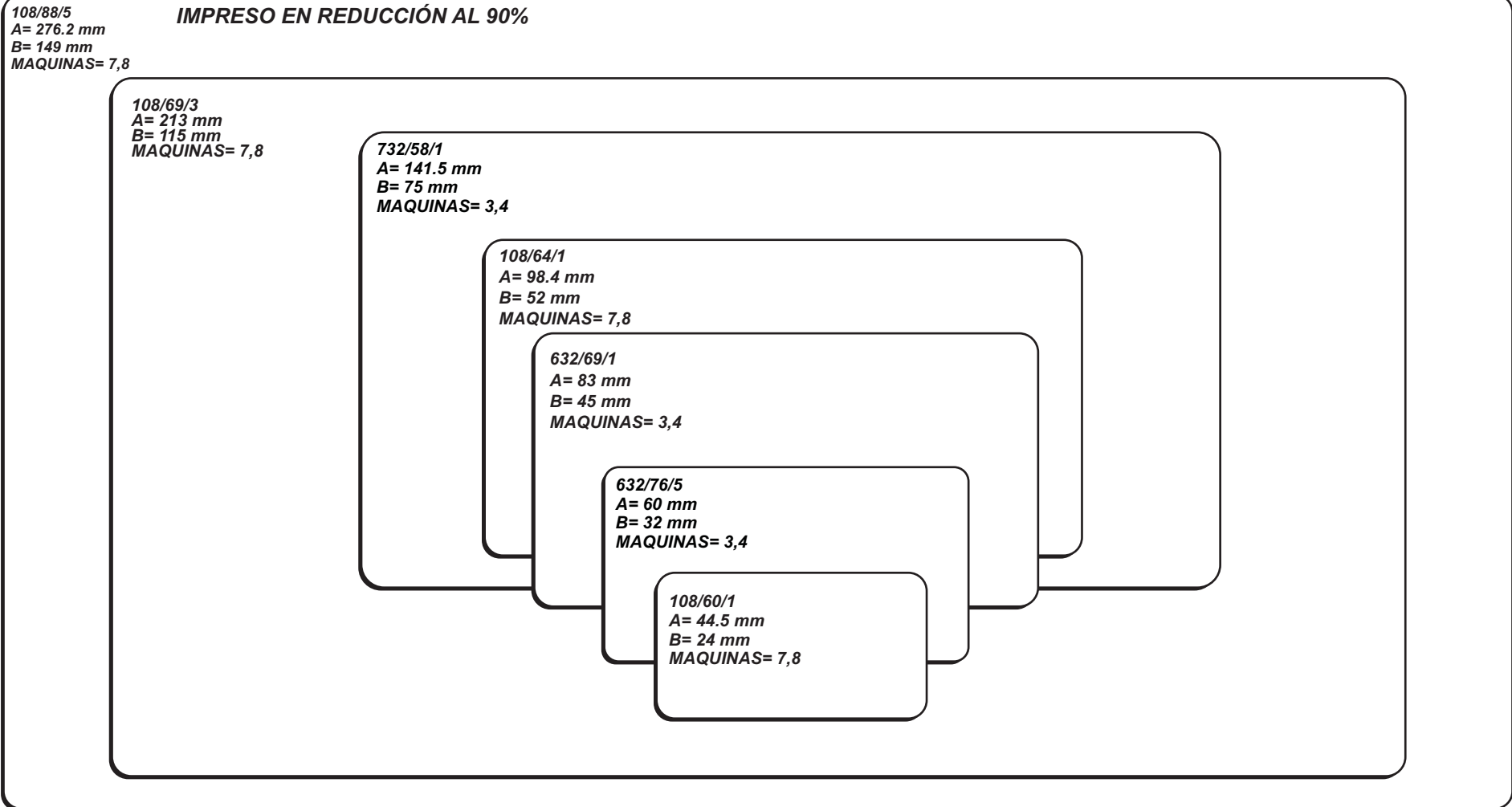



cintas y especialidades  
impresas s.a. de c.v.

108/82/5  
A= 257.35 mm  
B= 135 mm  
MAQUINAS= 7,8

632/99/5  
A= 243 mm  
B= 125 mm  
MAQUINAS= 3,4

**IMPRESO EN REDUCCION AL 75%**

108/102/1  
A= 319.5 mm  
B= 160.5 mm  
MAQUINAS= 7,8

632/72/1  
A= 176 mm  
B= 90 mm  
MAQUINAS= 3,4

108/90/2  
A= 139.7 mm  
B= 70 mm  
MAQUINAS= 7,8

108/74/1  
A= 114.4 mm  
B= 57.15 mm  
MAQUINAS= 7,8

632/73/1  
A= 88 mm  
B= 45 mm  
MAQUINAS= 3,4

632/54/1  
A= 64 mm  
B= 32 mm  
MAQUINAS= 3,4

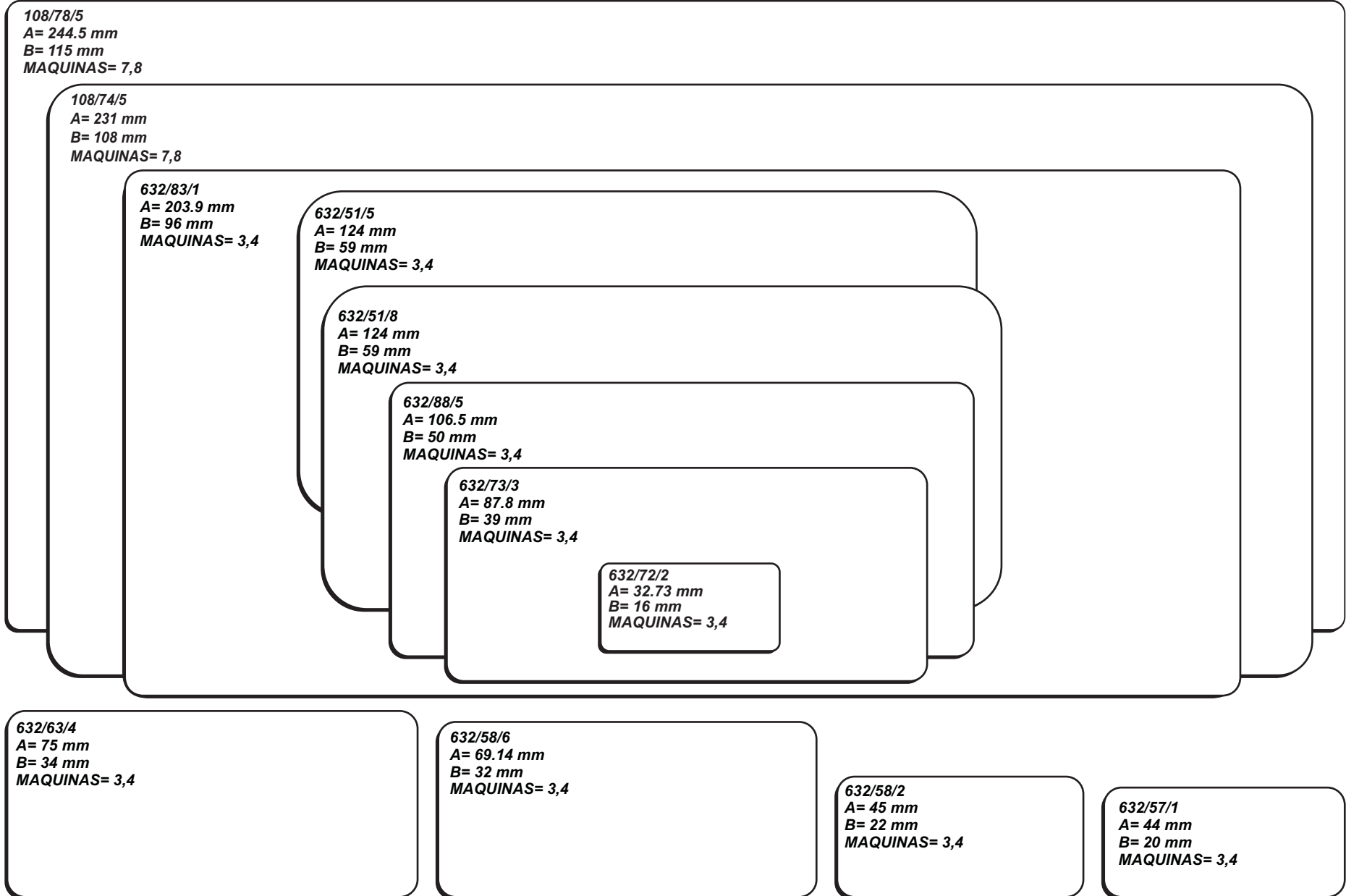



cintas y especialidades  
impresas s.a. de c.v.

108/84/2 **IMPRESO EN REDUCCION AL 97%**  
A= 264 mm  
B= 110 mm  
MAQUINAS= 7,8

108/84/1 **IMPRESO EN REDUCCION AL 97%**  
A= 263 mm  
B= 108 mm  
MAQUINAS= 7,8

108/81/3  
A= 252 mm  
B= 103 mm  
MAQUINAS= 7,8

632/87/3  
A= 213.8 mm  
B= 94 mm  
MAQUINAS= 3,4

108/55/3  
A= 171 mm  
B= 75 mm  
MAQUINAS= 7,8

108/66/1  
A= 101.6 mm  
B= 44.5 mm  
MAQUINAS= 7,8

632/63/7  
A= 36.1 mm  
B= 16 mm  
MAQUINAS= 3,4

632/76/6  
A= 60 mm  
B= 25 mm  
MAQUINAS= 3,4

632/64/8  
A= 76.2 mm  
B= 32 mm  
MAQUINAS= 3,4



108/78/1  
A= 245 mm  
B= 95 mm  
MAQUINAS= 7,8

632/71/4  
A= 173.5 mm  
B= 70 mm  
MAQUINAS= 3,4

632/58/5  
A= 141 mm  
B= 57 mm  
MAQUINAS= 3,4

632/59/11  
A= 70 mm  
B= 28 mm  
MAQUINAS= 3,4

108/90/1  
A= 139.7 mm  
B= 57 mm  
MAQUINAS= 7,8

108/80/4  
A= 123.5 mm  
B= 50 mm  
MAQUINAS= 7,8

632/68/5  
A= 81 mm  
B= 32 mm  
MAQUINAS= 3,4

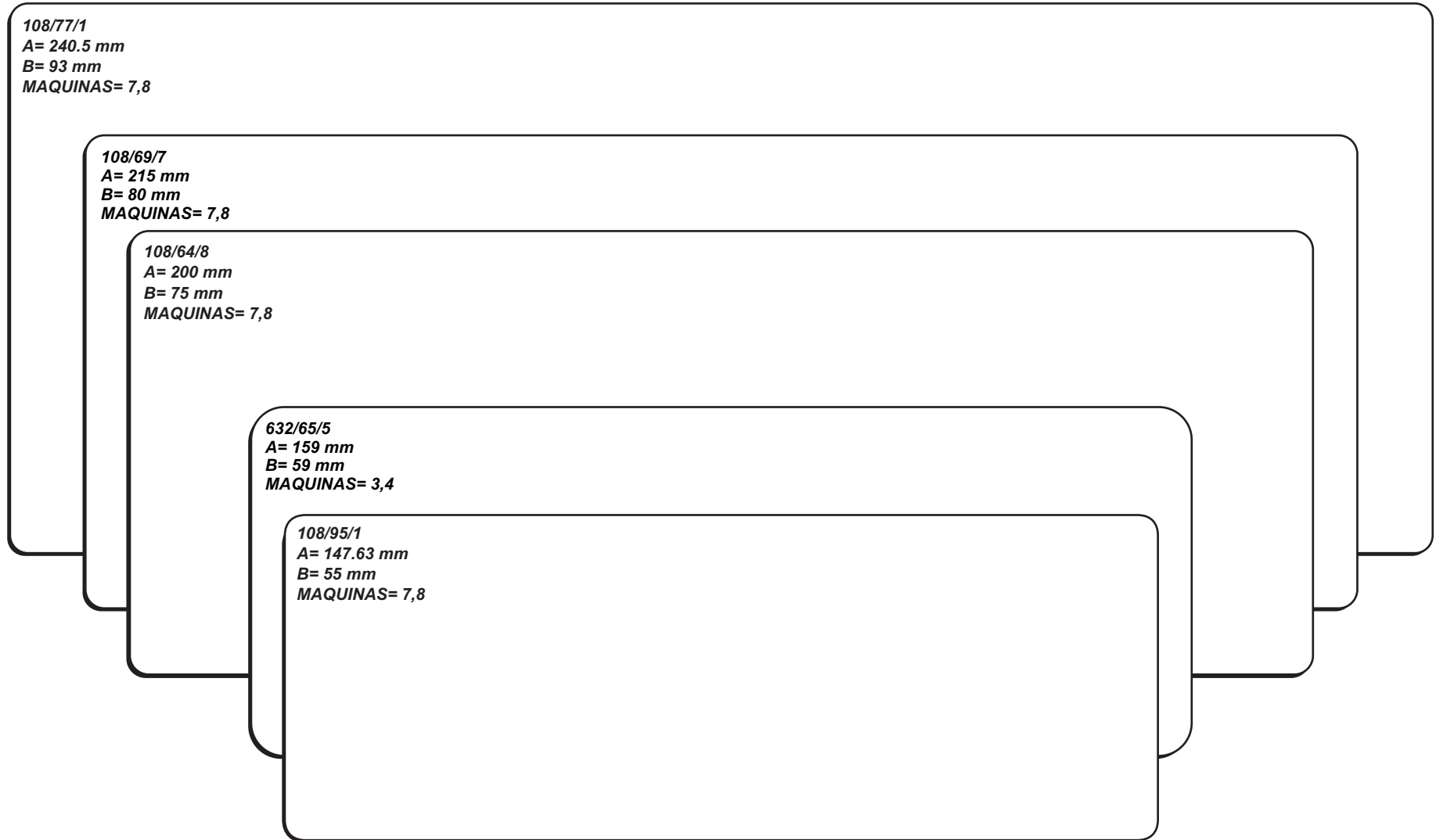



cintas y especialidades  
impresas s.a. de c.v.



**SUAJES RECTANGULOS HORIZONTALES**

**108/102/2\*** IMPRESO EN REDUCCION AL 85%  
A= 314 mm  
B= 114 mm  
MAQUINAS= 7,8

**108/81/4**  
A= 254 mm  
B= 96 mm  
MAQUINAS= 7,8

**108/71/2**  
A= 222.2 mm  
B= 80 mm  
MAQUINAS= 7,8

**632/65/1**  
A= 159 mm  
B= 58 mm  
MAQUINAS= 3,4

**632/70/2**  
A= 84 mm  
B= 30 mm  
MAQUINAS= 3,4



108/92/1 **IMPRESO EN REDUCCION AL 90%**  
A= 289 mm  
B= 95 mm  
MAQUINAS= 7,8

108/78/6  
A= 244.5 mm  
B= 85 mm  
MAQUINAS= 7,8

108/53/1  
A= 165 mm  
B= 57 mm  
MAQUINAS= 7,8

632/66/6  
A= 161.5 mm  
B= 57 mm  
MAQUINAS= 3,4

632/88/2  
A= 106.5 mm  
B= 36 mm  
MAQUINAS= 3,4

632/53/5  
A= 63 mm  
B= 22 mm  
MAQUINAS= 3,4

632/76/2  
A= 91 mm  
B= 32 mm  
MAQUINAS= 3,4

632/64/7  
A= 76.6 mm  
B= 27 mm  
MAQUINAS= 3,4

632/84/1  
A= 66.5 mm  
B= 22 mm  
MAQUINAS= 3,4

632/64/10  
A= 76 mm  
B= 25 mm  
MAQUINAS= 3,4



cintas y especialidades  
impresas s.a. de c.v.

108/147/1 **IMPRESO EN REDUCCION AL 55%**  
A= 464 mm  
B= 142 mm  
MAQUINAS= 7,8

108/102/4 **IMPRESO EN REDUCCION AL 80%**  
A= 320.6 mm  
B= 100 mm  
MAQUINAS= 7,8

632/82/4  
A= 201.3 mm  
B= 62 mm  
MAQUINAS= 3,4

632/99/2  
A= 120.2 mm  
B= 39 mm  
MAQUINAS= 3,4

108/64/7  
A= 200 mm  
B= 62 mm  
MAQUINAS= 7,8

632/65/4  
A= 158.9 mm  
B= 50 mm  
MAQUINAS= 3,4

108/90/4  
A= 139 mm  
B= 42 mm  
MAQUINAS= 7,8



cintas y especialidades  
impresas s.a. de c.v.

**108/147/2** IMPRESO EN REDUCCIÓN AL 55%  
A= 463 mm  
B= 134 mm  
MAQUINAS= 7,8

**108/80/5**  
A= 250.5 mm  
B= 71 mm  
MAQUINAS= 7,8

**108/64/3**  
A= 200 mm  
B= 58 mm  
MAQUINAS= 7,8

**632/79/9**  
A= 95.3 mm  
B= 28 mm  
MAQUINAS= 3,4

**108/50/1**  
A= 76 mm  
B= 22 mm  
MAQUINAS= 7,8

**108/81/5**  
A= 252 mm  
B= 73 mm  
MAQUINAS= 7,8

**108/59/1**  
A= 184.15 mm  
B= 53.5 mm  
MAQUINAS= 7,8

**108/55/2**  
A= 83.8 mm  
B= 24 mm  
MAQUINAS= 7,8

**632/70/3**  
A= 83.8 mm  
B= 24 mm  
MAQUINAS= 3,4

**632/68/7**  
A= 53 mm  
B= 15 mm  
MAQUINAS= 3,4

 cintas y especialidades  
 impresas s.a. de c.v.

**108/102/3 IMPRESO EN REDUCCION AL 80%**

 A= 320.6 mm  
 B= 73 mm  
 MAQUINAS= 7,8

**108/77/6**  
 A= 241.3 mm  
 B= 64.3 mm  
 MAQUINAS= 7,8

**108/75/3**  
 A= 235 mm  
 B= 47 mm  
 MAQUINAS= 7,8

**632/77/1**  
 A= 188.9 mm  
 B= 40 mm  
 MAQUINAS= 3,4

**108/50/3**  
 A= 155.6 mm  
 B= 35 mm  
 MAQUINAS= 7,8

**632/91/3**  
 A= 110 mm  
 B= 30 mm  
 MAQUINAS= 3,4

**632/64/12**  
 A= 76.6 mm  
 B= 18 mm  
 MAQUINAS= 3,4

**108/96/1**  
 A= 149.22 mm  
 B= 30 mm  
 MAQUINAS= 7,8

**632/73/4**  
 A= 87.8 mm  
 B= 24.5 mm  
 MAQUINAS= 3,4

**632/64/11**  
 A= 76.5 mm  
 B= 20 mm  
 MAQUINAS= 3,4

**632/75/1**  
 A= 90 mm  
 B= 22 mm  
 MAQUINAS= 3,4

**632/85/1**  
 A= 103 mm  
 B= 27 mm  
 MAQUINAS= 3,4

**632/67/4**  
 A= 80.5 mm  
 B= 20 mm  
 MAQUINAS= 3,4

**632/76/4**  
 A= 60 mm  
 B= 15 mm  
 MAQUINAS= 3,4

**632/60/3**  
 A= 71 mm  
 B= 20 mm  
 MAQUINAS= 3,4



cintas y especialidades  
impresas s.a. de c.v.

**IMPRESO EN REDUCCION AL 90%**

108/90/6  
A= 282.57 mm  
B= 50 mm  
MAQUINAS= 7,8

108/80/3  
A= 251.3 mm  
B= 64 mm  
MAQUINAS= 7,8

632/99/3  
A= 243.7 mm  
B= 42 mm  
MAQUINAS= 3,4

108/60/10  
A= 187.3 mm  
B= 31 mm  
MAQUINAS= 7,8

632/66/8  
A= 161 mm  
B= 31 mm  
MAQUINAS= 3,4

632/51/6  
A= 126.5 mm  
B= 15 mm  
MAQUINAS= 3,4

108/82/3 - 108/82/4  
A= 257.1 mm  
B= 40 mm  
MAQUINAS= 7,8

108/74/7  
A= 231.7 mm  
B= 30 mm  
MAQUINAS= 7,8

108/55/4  
A= 171.5 mm  
B= 30 mm  
MAQUINAS= 7,8

108/54/3  
A= 168.3 mm  
B= 24 mm  
MAQUINAS= 7,8

632/86/1  
A= 104 mm  
B= 18 mm  
MAQUINAS= 3,4

632/88/1  
A= 106.5 mm  
B= 10 mm  
MAQUINAS= 3,4

632/56/2  
A= 31.7 mm  
B= 6 mm  
MAQUINAS= 3,4



cintas y especialidades  
impresas s.a. de c.v.



**SUAJES CIRCULOS**

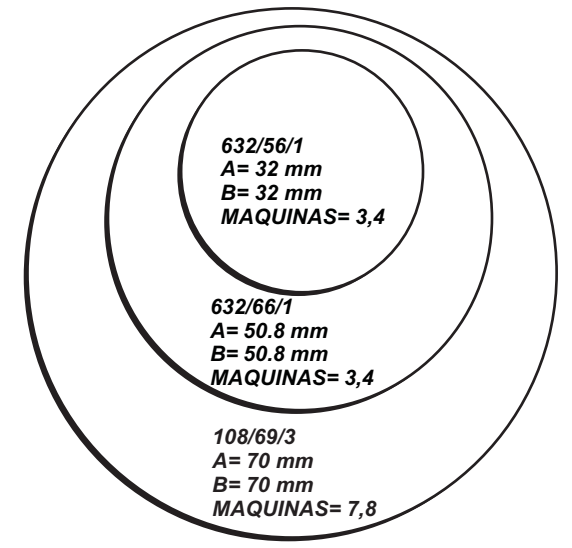
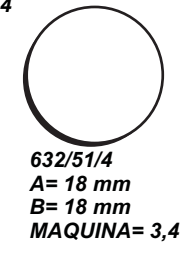
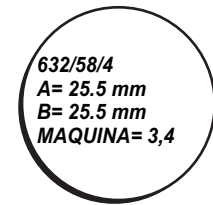
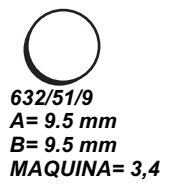
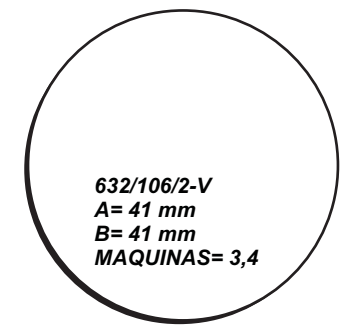
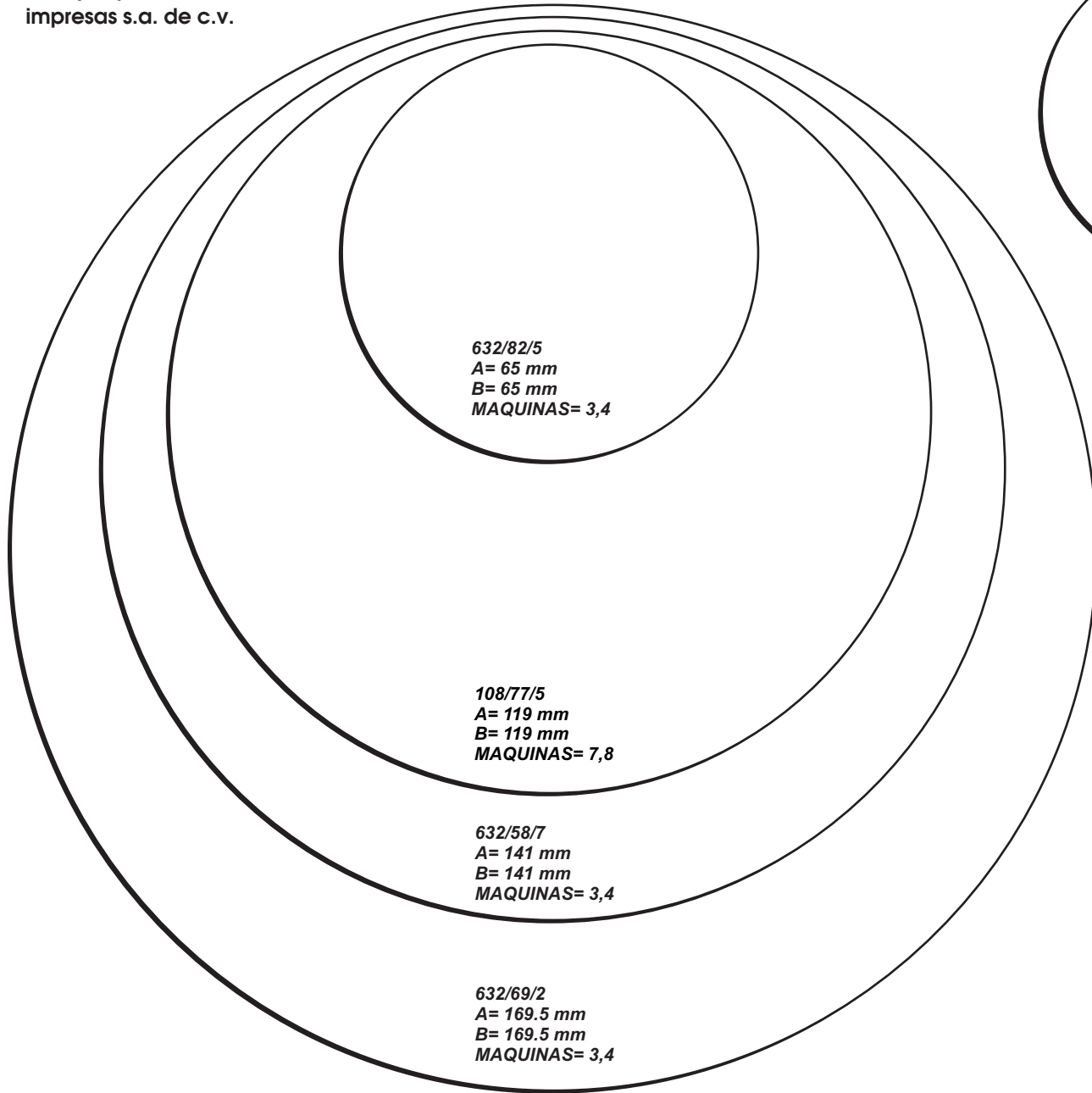



cintas y especialidades  
impresas s.a. de c.v.

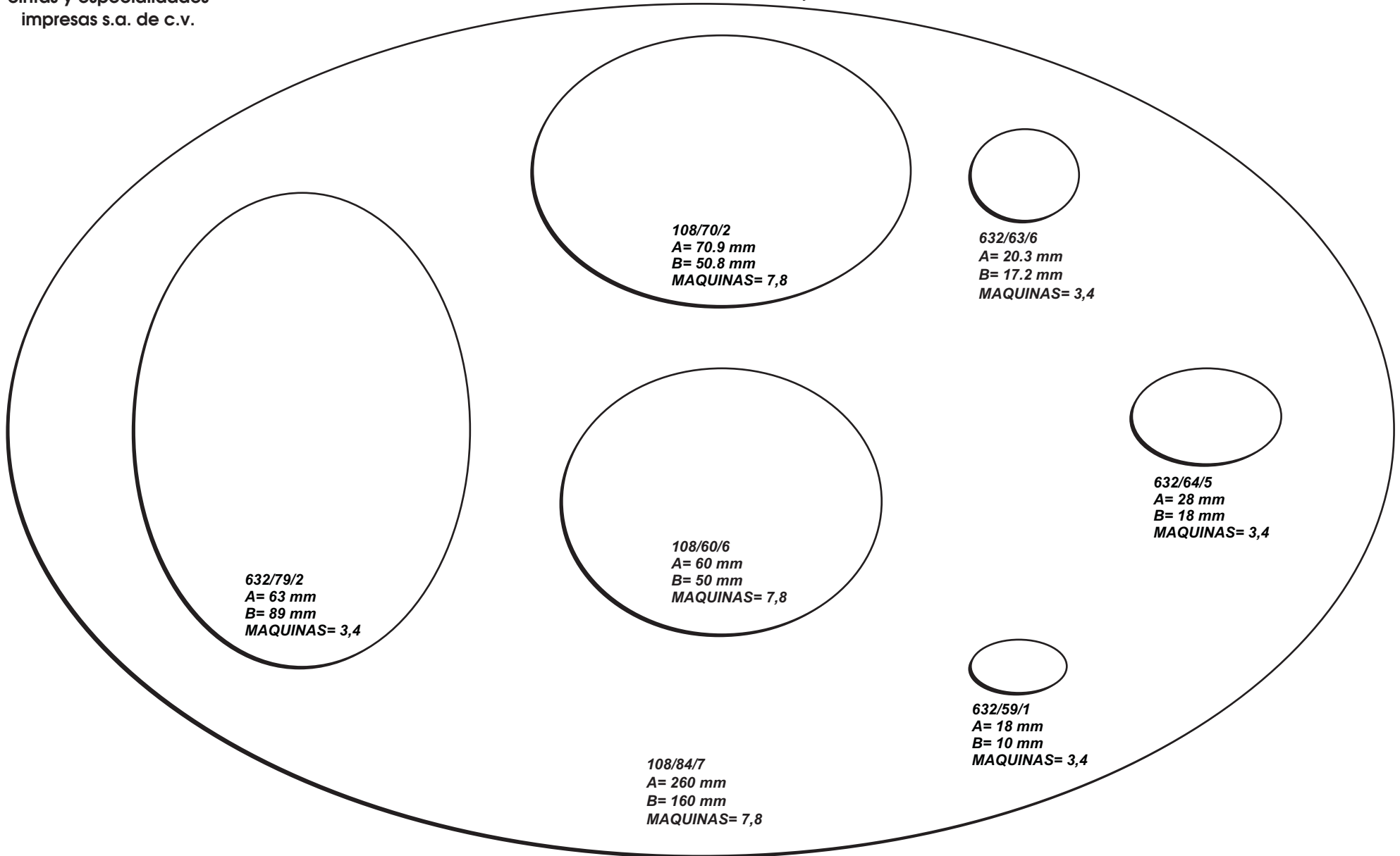



cintas y especialidades  
impresas s.a. de c.v.

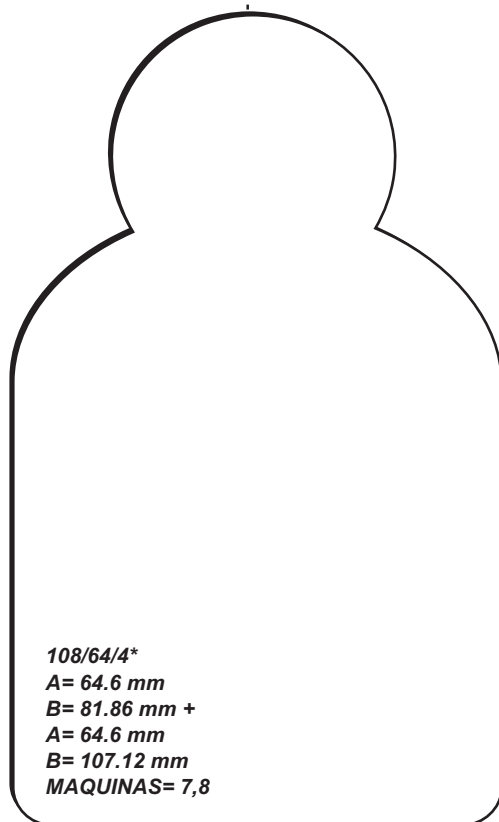
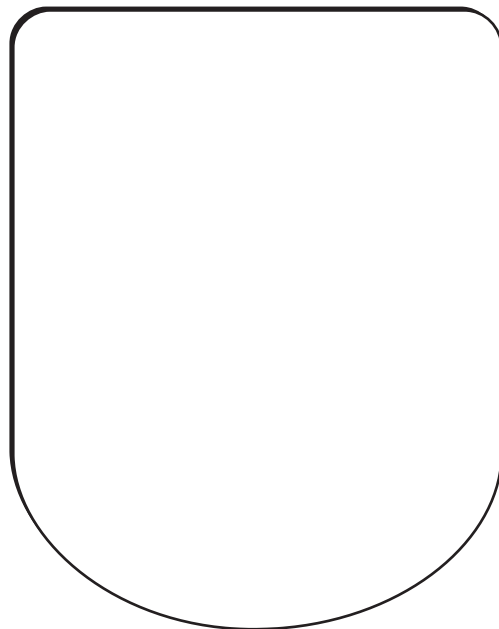

108/64/4\*  
A= 64.6 mm  
B= 81.86 mm +  
A= 64.6 mm  
B= 107.12 mm  
MAQUINAS= 7,8

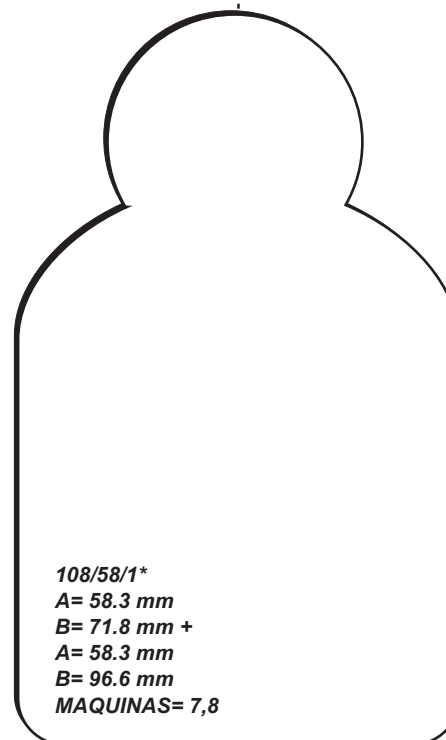
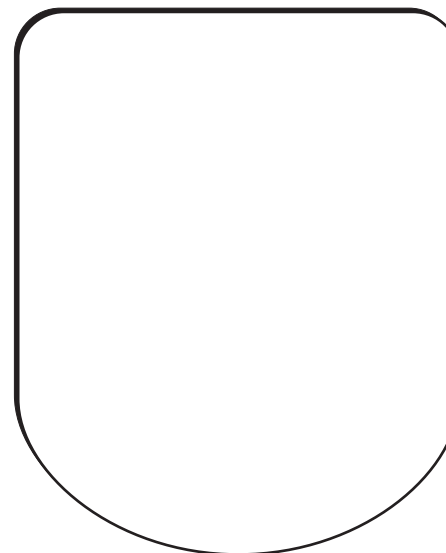

108/58/1\*  
A= 58.3 mm  
B= 71.8 mm +  
A= 58.3 mm  
B= 96.6 mm  
MAQUINAS= 7,8



cintas y especialidades  
impresas s.a. de c.v.

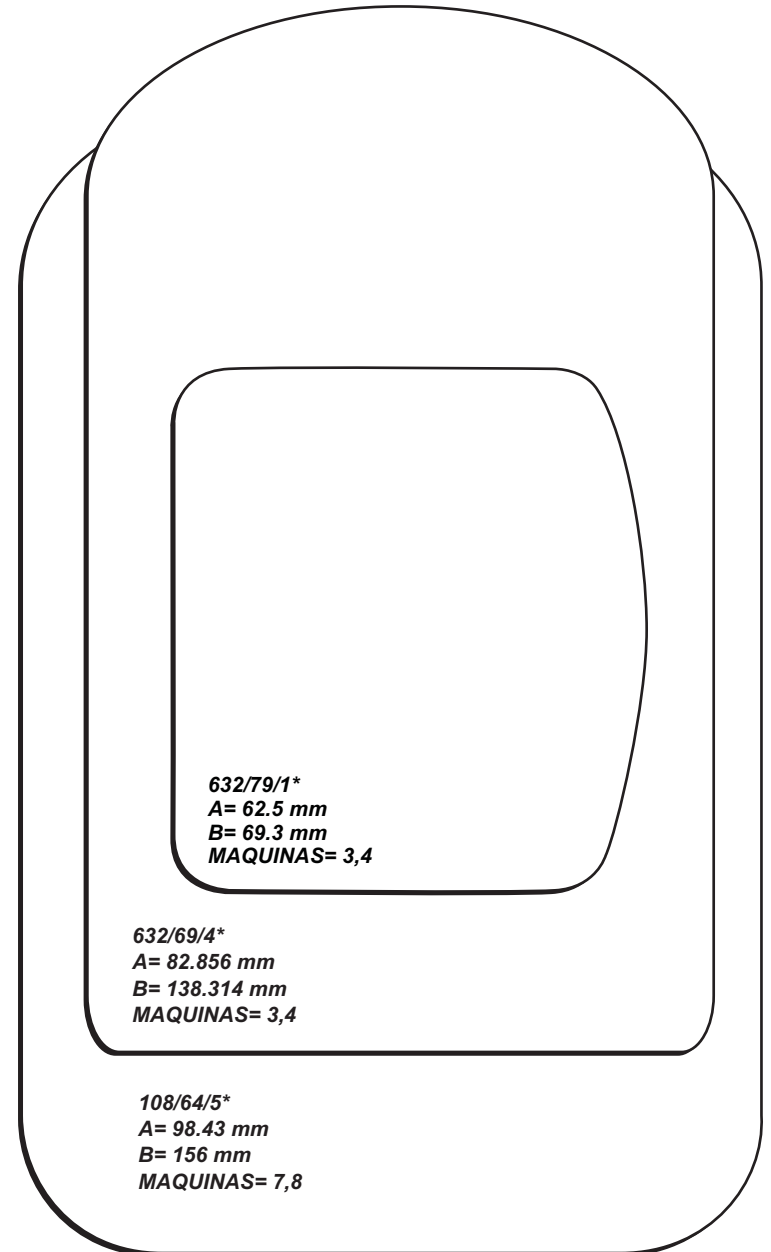
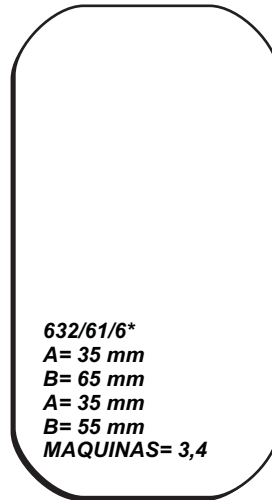
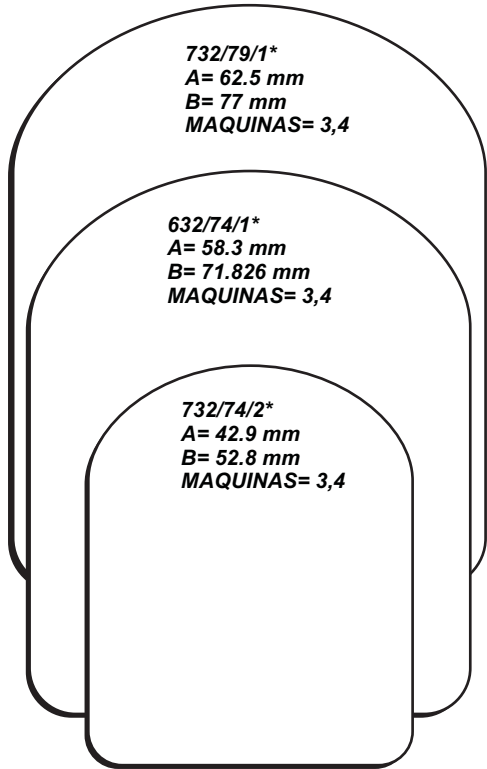



108/69/2\*  
A= 69.85 mm  
B= 110.88 mm  
MAQUINAS= 7,8

108/67/3\*  
A= 50.01 mm  
B= 99.36 mm  
MAQUINAS= 7,8

632/71/4\*  
A= 173.87 mm  
B= 95 mm  
MAQUINAS= 3,4

SUAJE DE 2 CAVIDADES  
IMAGEN ESPEJO UNA DE LA OTRA  
PARA FRENTE Y REVERSO

632/117/1\*  
A= 142.2 mm  
B= 63.5 mm  
MAQUINAS= 3,4

632/64/9 \*  
A= 76 mm  
B= 52 mm  
MAQUINAS= 3,4

SUAJE DE 2 CAVIDADES  
IMAGEN ESPEJO UNA DE LA OTRA  
PARA FRENTE Y REVERSO

632/67/2\*  
A= 163.5 mm  
B= 77 mm  
MAQUINAS= 3,4

732/71/1\*  
A= 84.93 mm  
B= 63.5 mm  
MAQUINAS= 3,4



632/73/5\*  
A= 178.8 mm  
B= 60 mm  
MAQUINAS= 3,4

632/59/9\*  
A= 70 mm  
B= 130 mm  
MAQUINAS= 3,4

108/66/2\*  
A= 66.6 mm  
B= 103.5 mm  
MAQUINAS= 7,8

108/66/3\*  
A= 38.7 mm  
B= 61 mm  
MAQUINAS= 7,8



cintas y especialidades  
impresas s.a. de c.v.

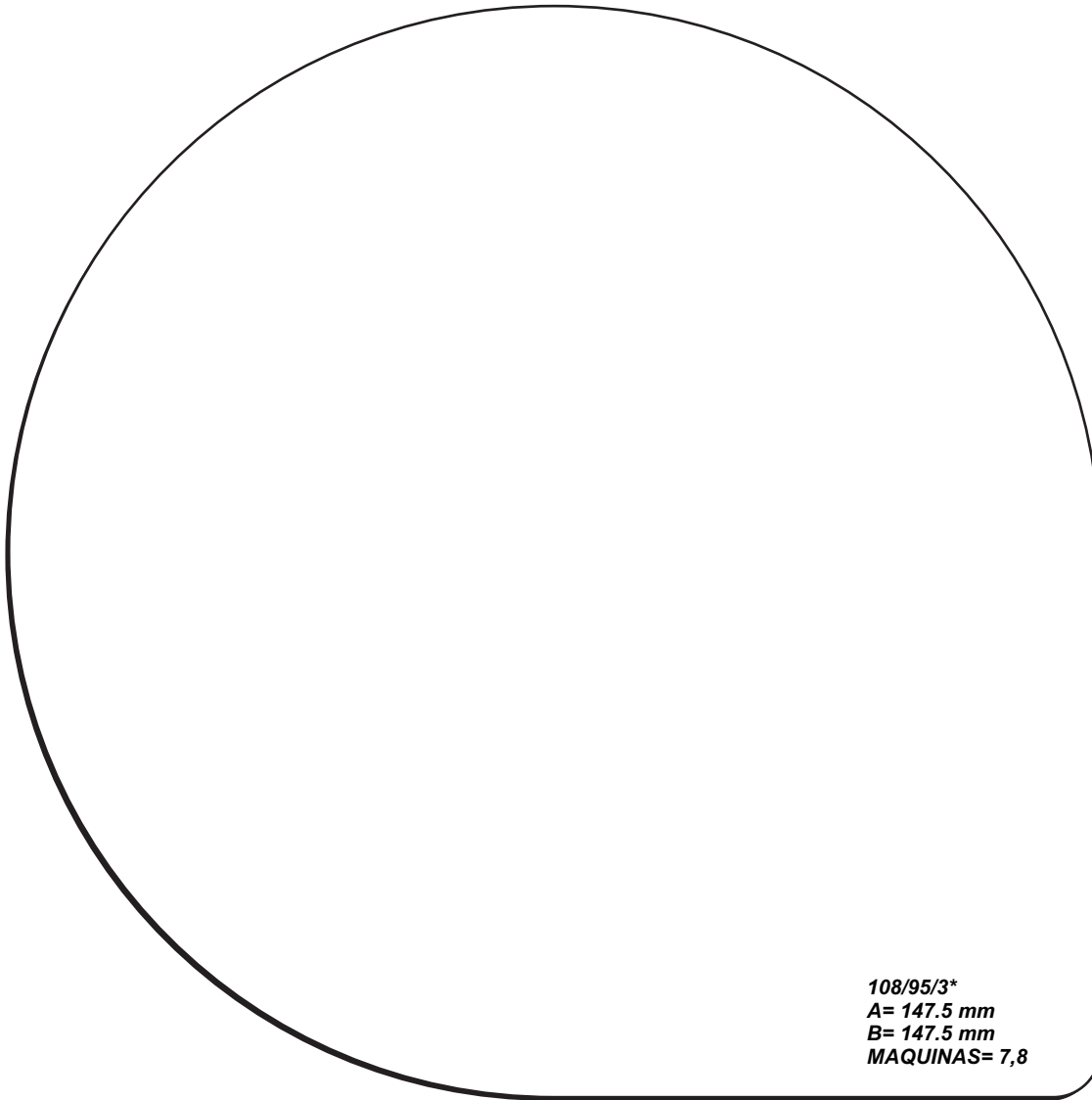

*108/95/3\**  
*A= 147.5 mm*  
*B= 147.5 mm*  
*MAQUINAS= 7,8*

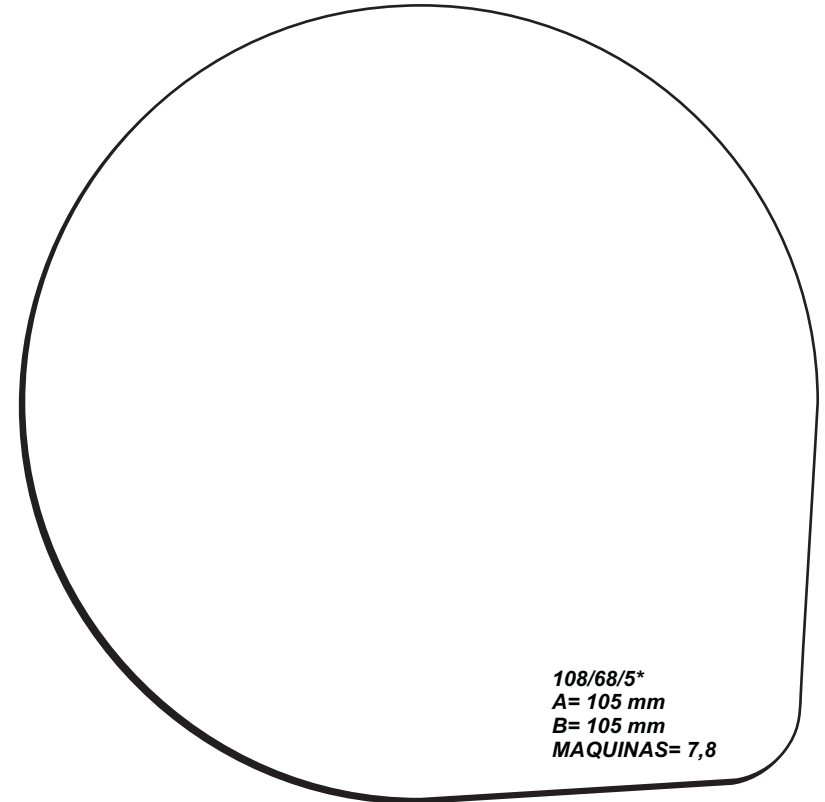

*108/68/5\**  
*A= 105 mm*  
*B= 105 mm*  
*MAQUINAS= 7,8*



cintas y especialidades  
impresas s.a. de c.v.

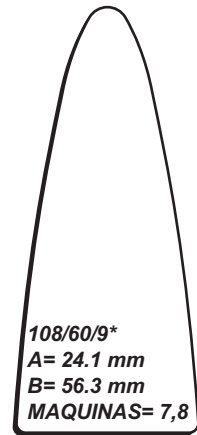
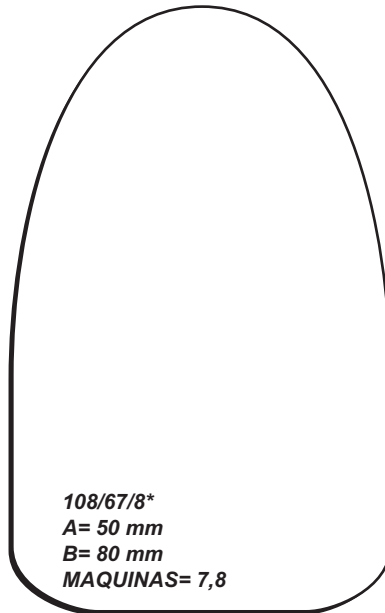
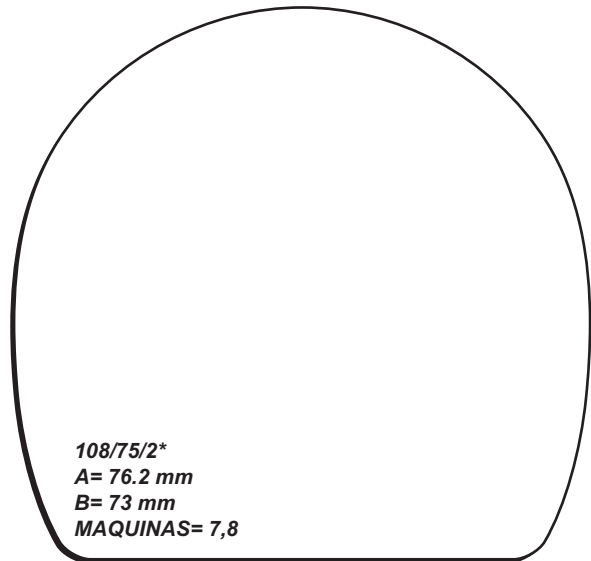
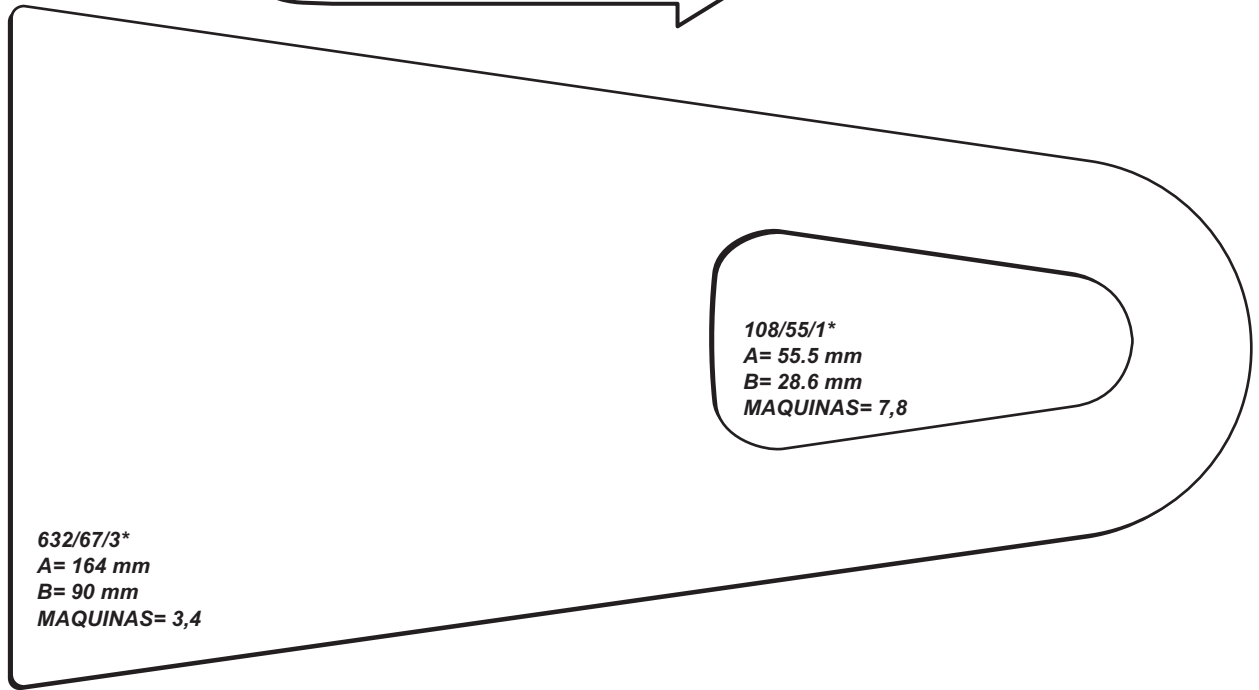
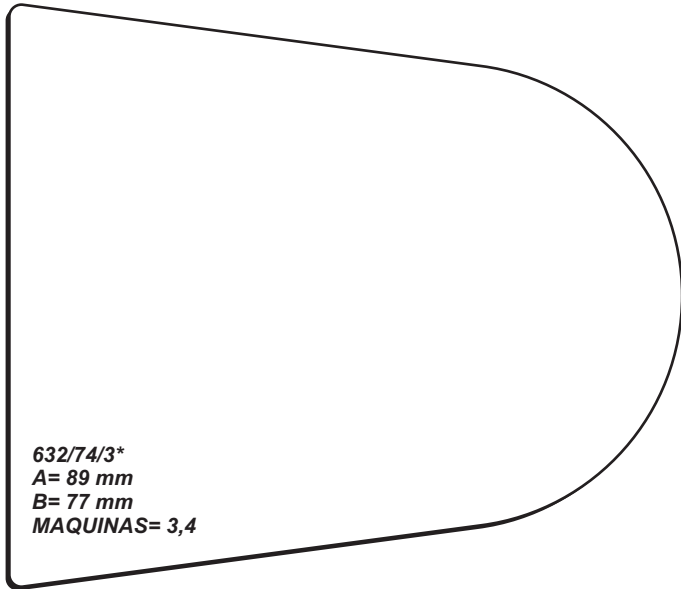



cintas y especialidades  
impresas s.a. de c.v.

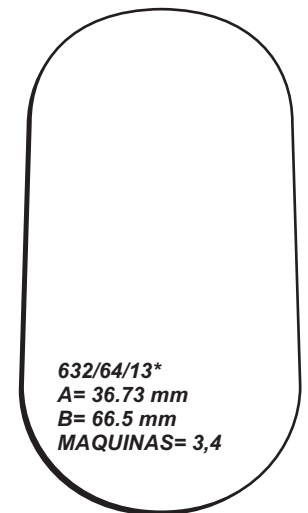
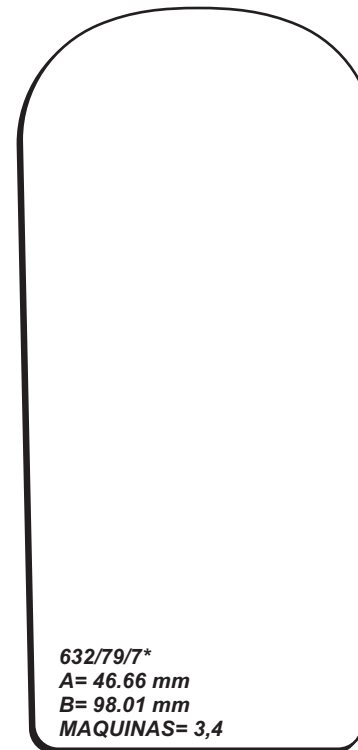
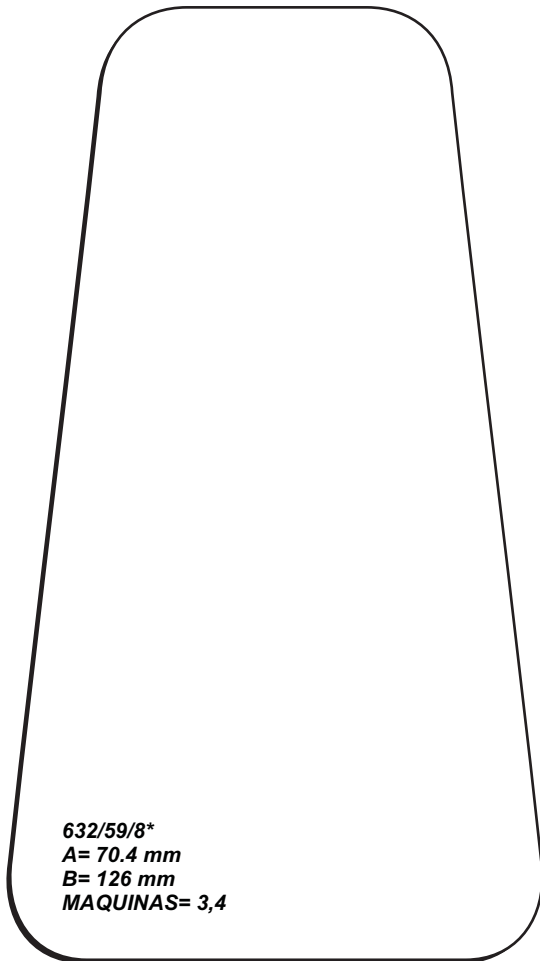



cintas y especialidades  
impresas s.a. de c.v.

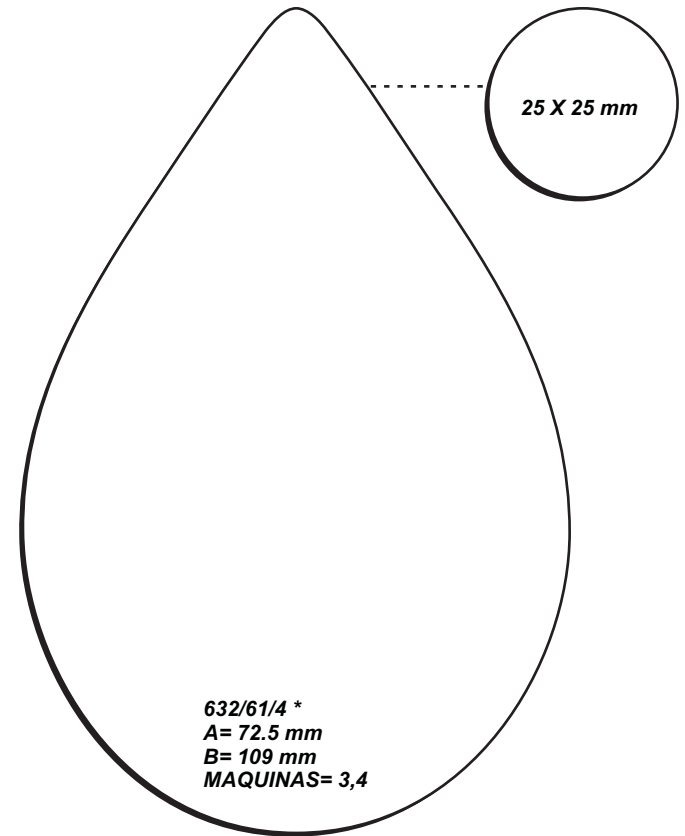
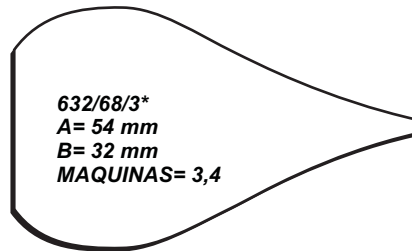
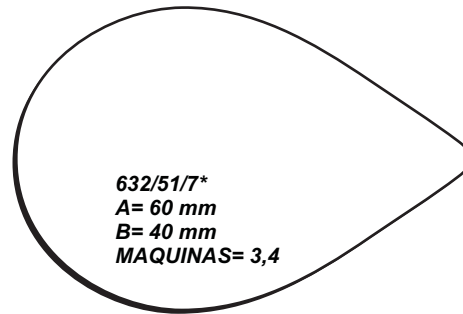
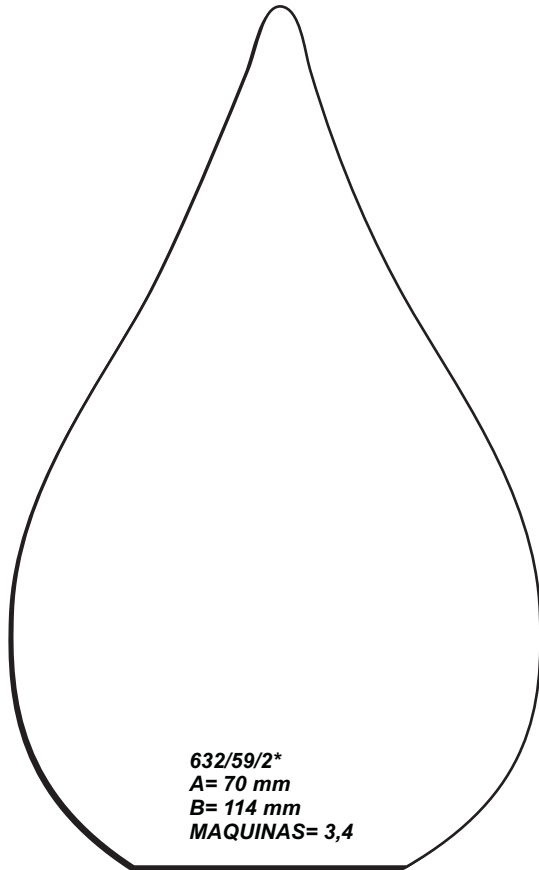

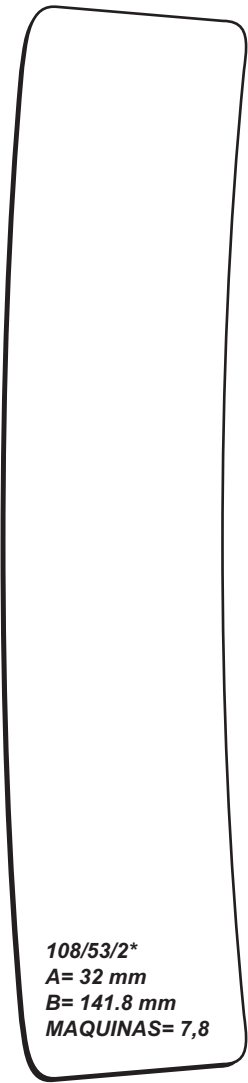

108/53/2\*  
A= 32 mm  
B= 141.8 mm  
MAQUINAS= 7,8

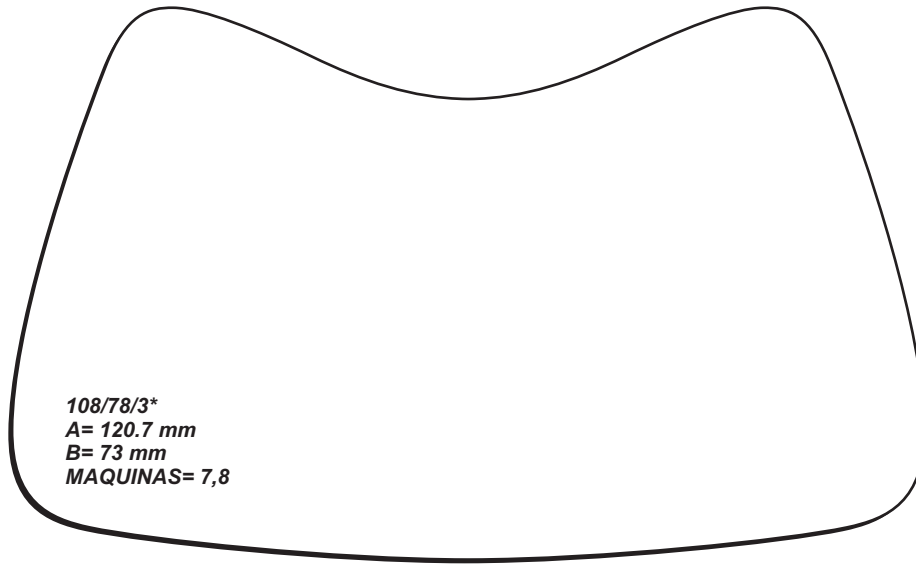

108/78/3\*  
A= 120.7 mm  
B= 73 mm  
MAQUINAS= 7,8

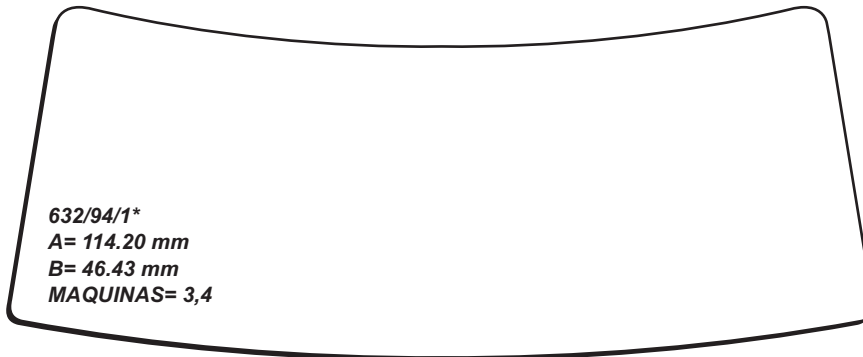

632/94/1\*  
A= 114.20 mm  
B= 46.43 mm  
MAQUINAS= 3,4



632/53/4\*  
A= 23.36 mm  
B= 12.72 mm  
MAQUINAS= 3,4

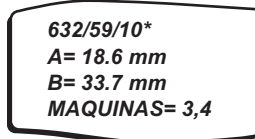

632/59/10\*  
A= 18.6 mm  
B= 33.7 mm  
MAQUINAS= 3,4

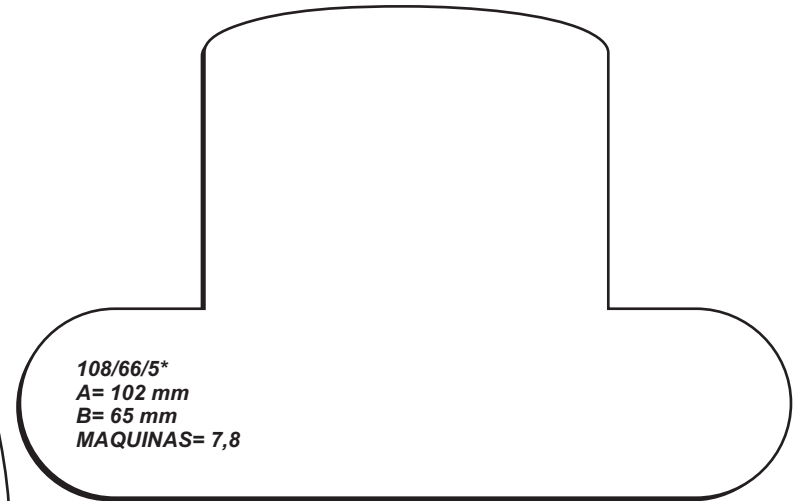

108/66/5\*  
A= 102 mm  
B= 65 mm  
MAQUINAS= 7,8

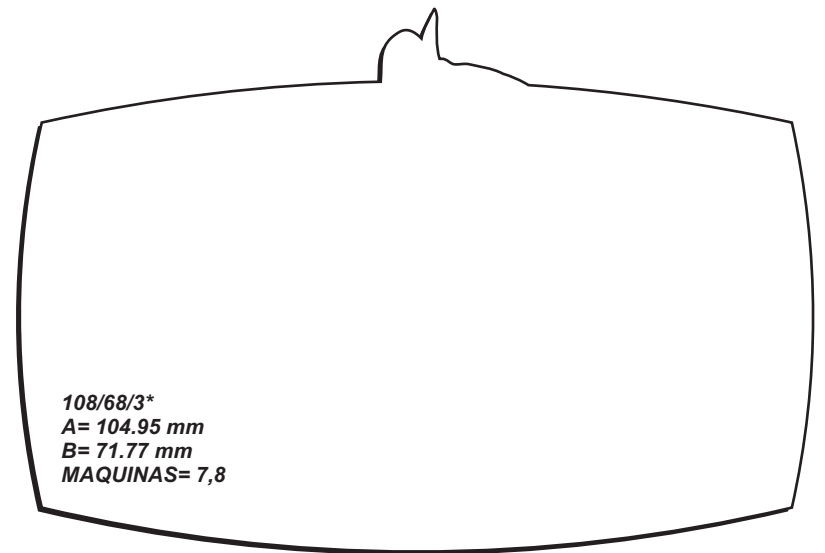

108/68/3\*  
A= 104.95 mm  
B= 71.77 mm  
MAQUINAS= 7,8



cintas y especialidades  
impresas s.a. de c.v.

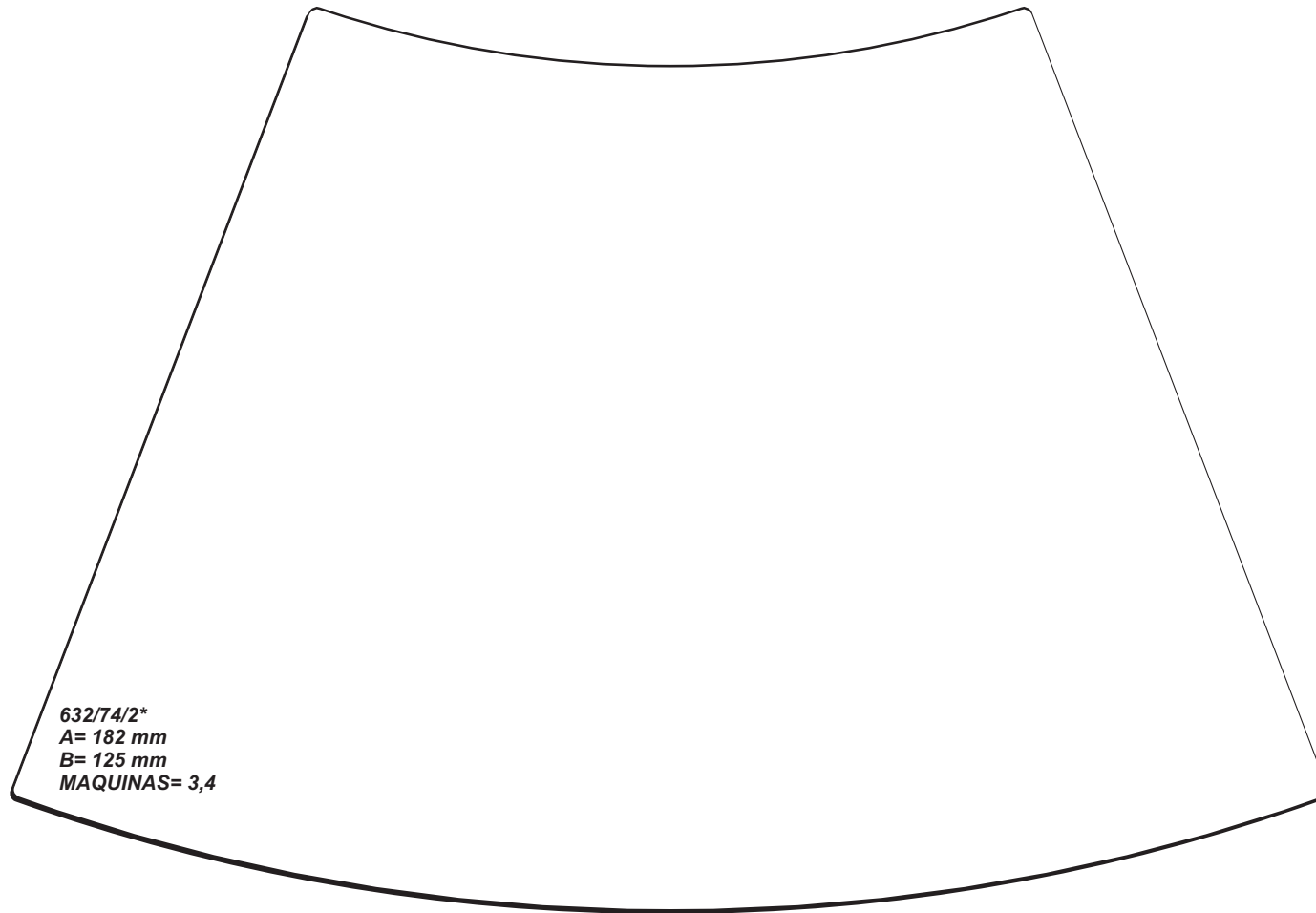

632/74/2\*  
A= 182 mm  
B= 125 mm  
MAQUINAS= 3,4



cintas y especialidades  
impresas s.a. de c.v.

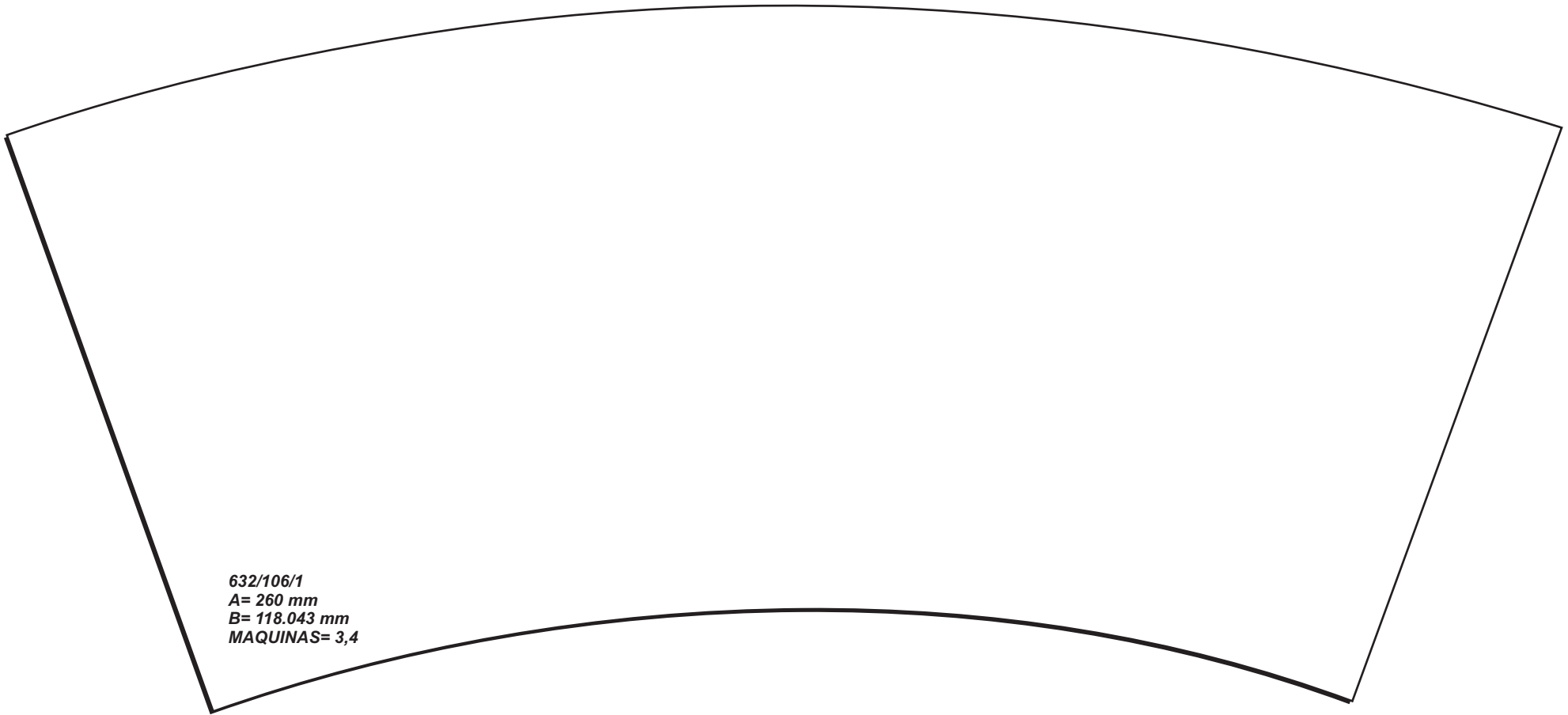

632/106/1  
A= 260 mm  
B= 118.043 mm  
MAQUINAS= 3,4



cintas y especialidades  
impresas s.a. de c.v.



108/104/1\*  
A= 327 mm  
B= 165 mm  
MAQUINAS= 7,8

**IMPRESO EN REDUCCION AL 75%**



cintas y especialidades  
impresas s.a. de c.v.

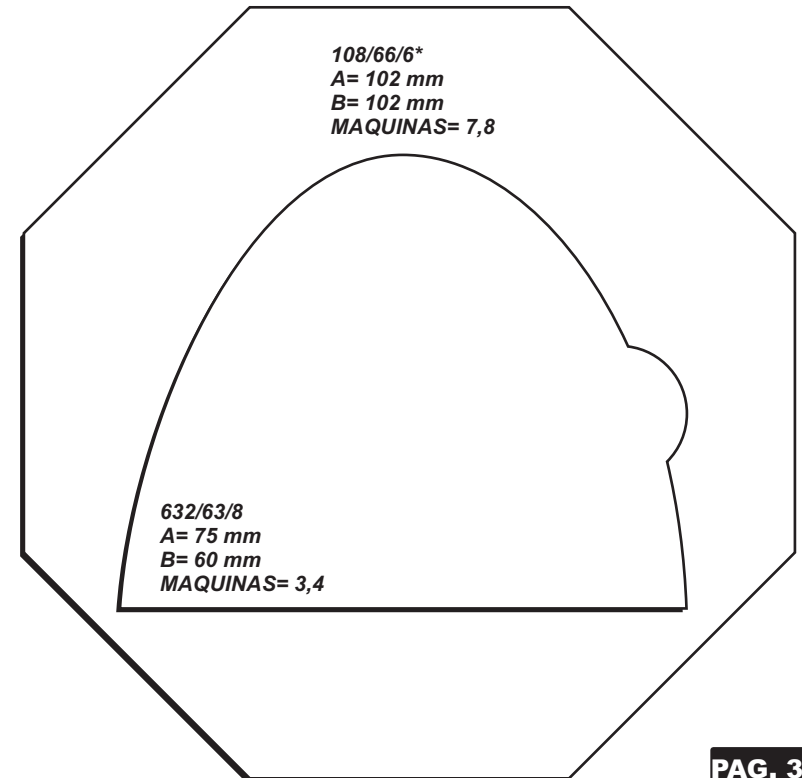
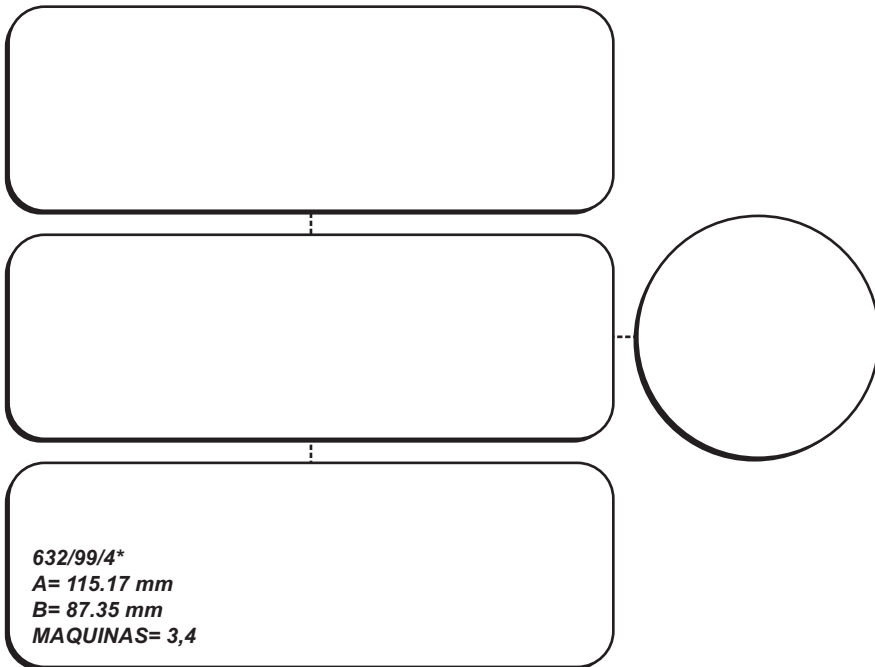
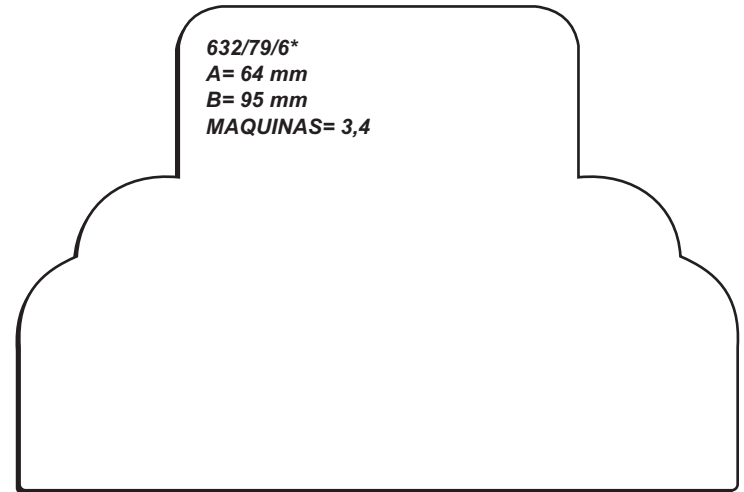
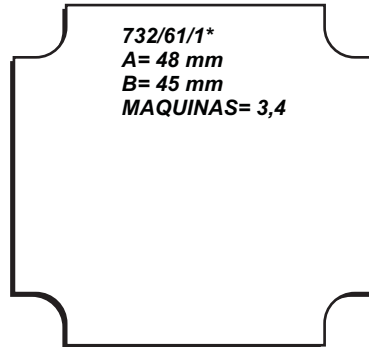
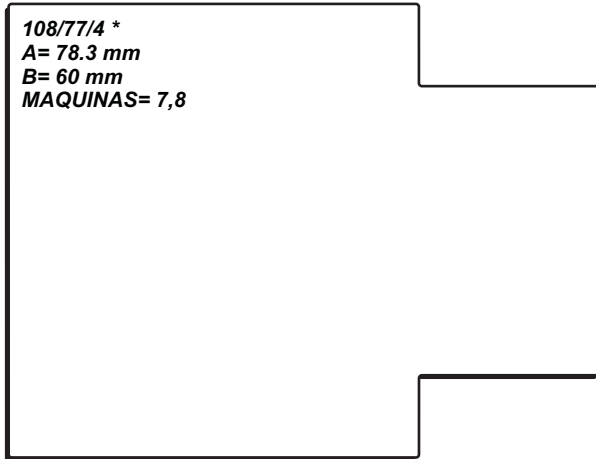



cintas y especialidades  
impresas s.a. de c.v.



**SUAJES ESPECIALES**

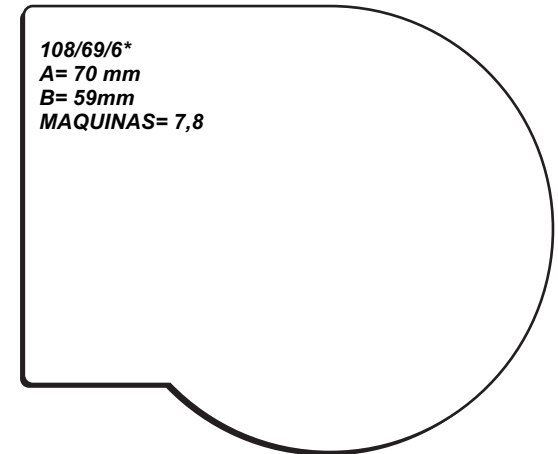
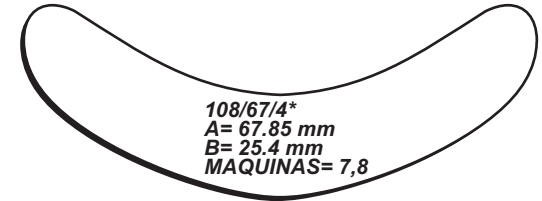
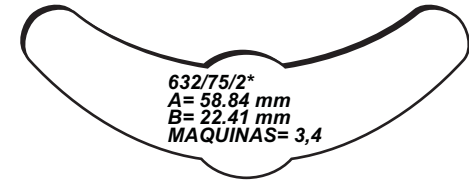
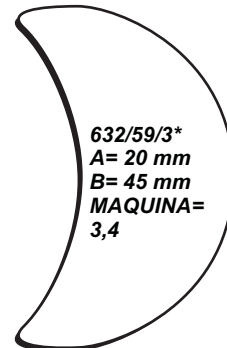
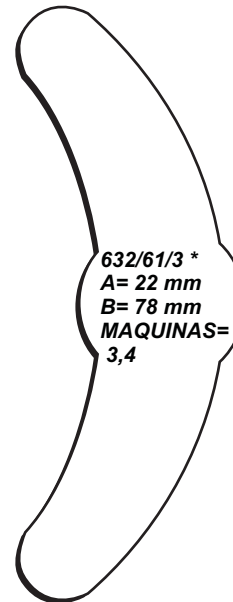
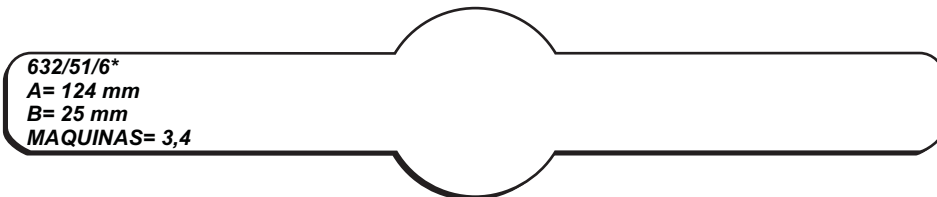
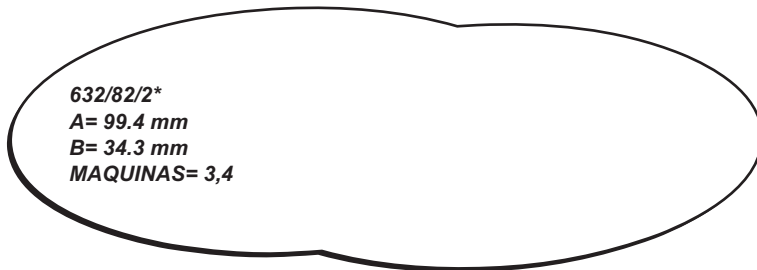
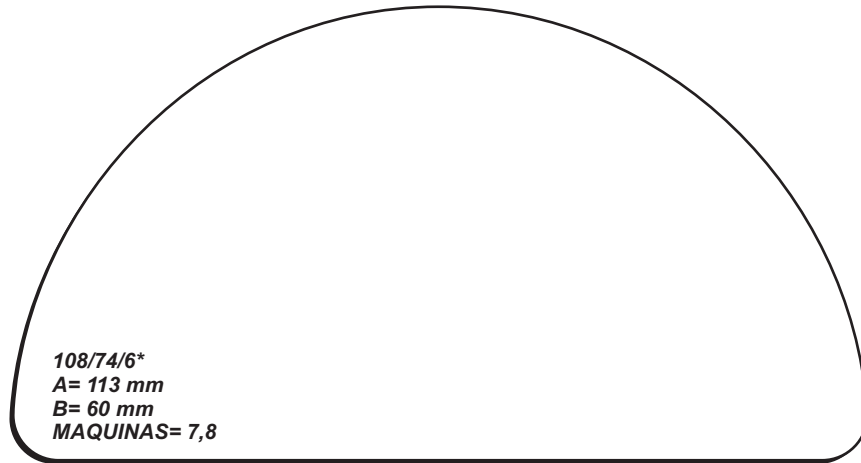



cintas y especialidades  
impresas s.a. de c.v.

**SUAJES ESPECIALES**

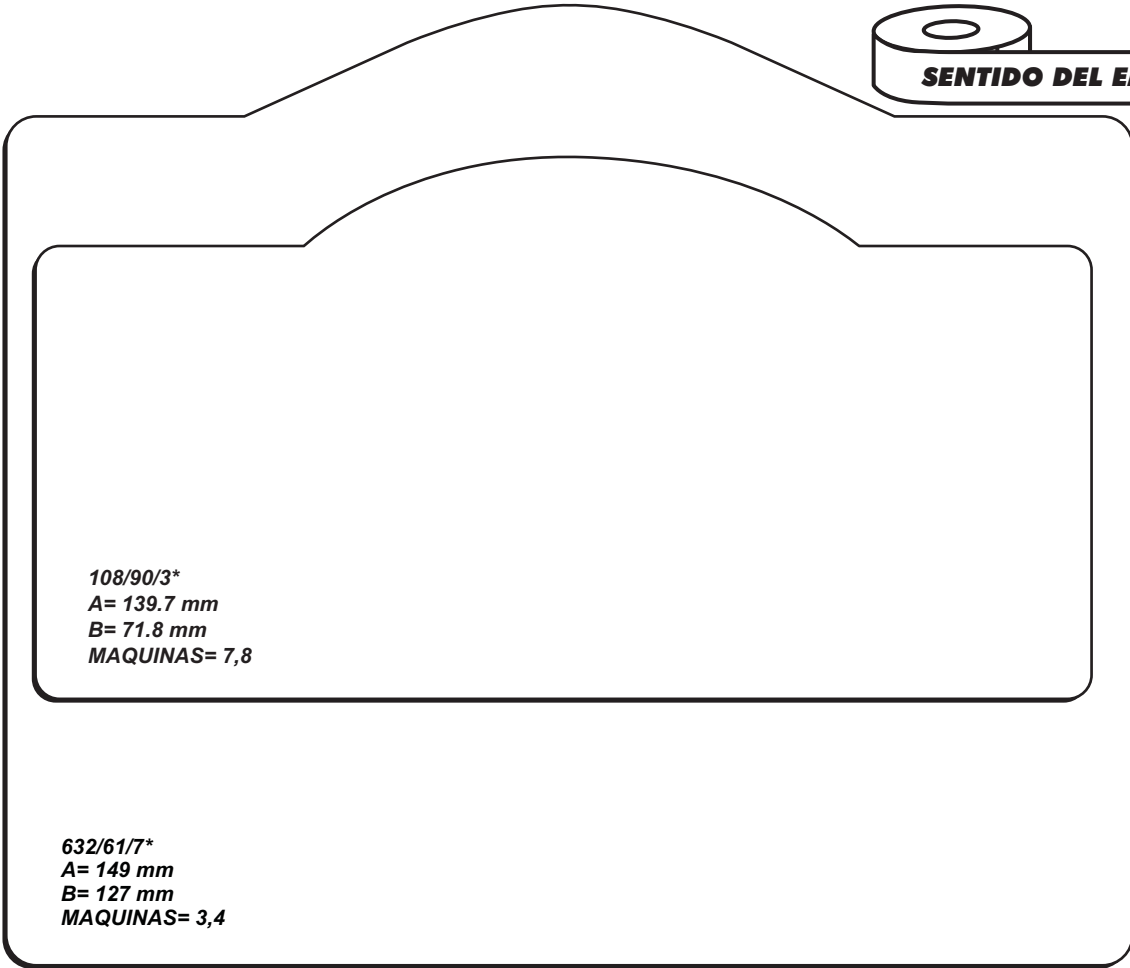

108/90/3\*  
A= 139.7 mm  
B= 71.8 mm  
MAQUINAS= 7,8

632/61/7\*  
A= 149 mm  
B= 127 mm  
MAQUINAS= 3,4

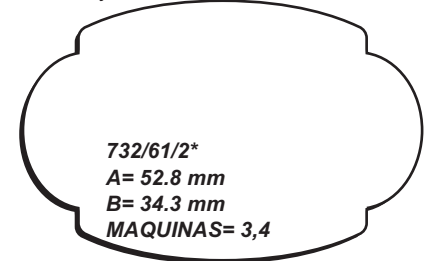

732/61/2\*  
A= 52.8 mm  
B= 34.3 mm  
MAQUINAS= 3,4

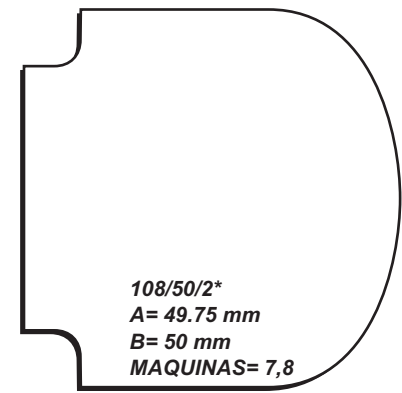

108/50/2\*  
A= 49.75 mm  
B= 50 mm  
MAQUINAS= 7,8

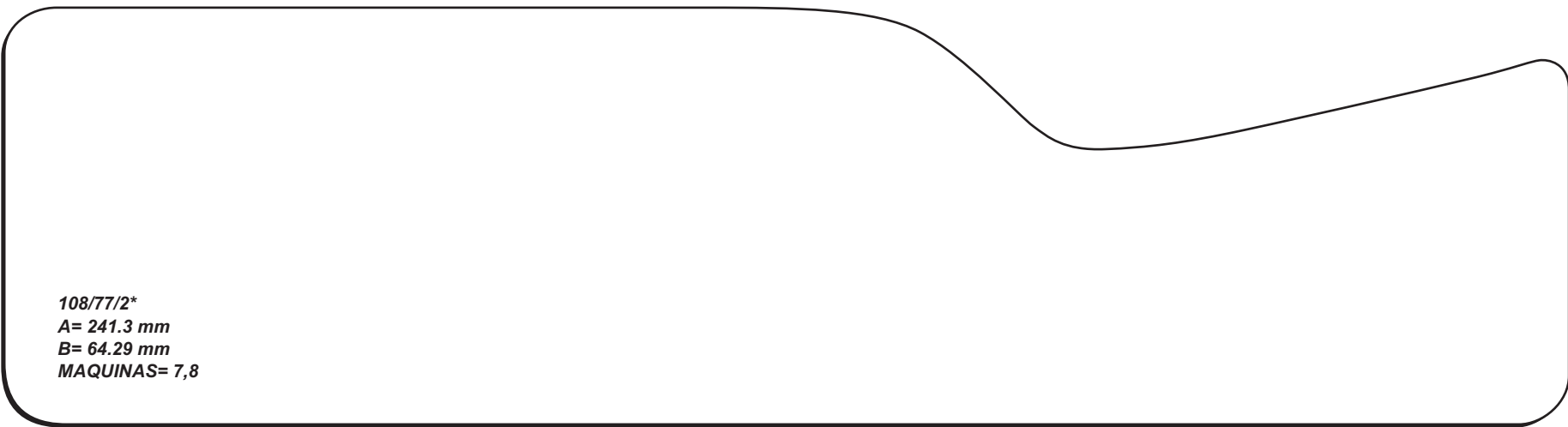

108/77/2\*  
A= 241.3 mm  
B= 64.29 mm  
MAQUINAS= 7,8



cintas y especialidades  
impresas s.a. de c.v.

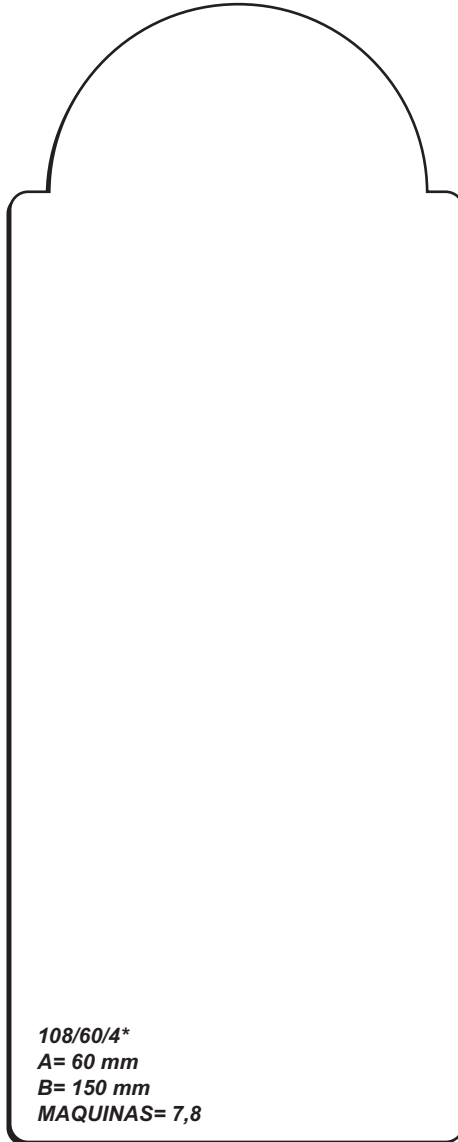
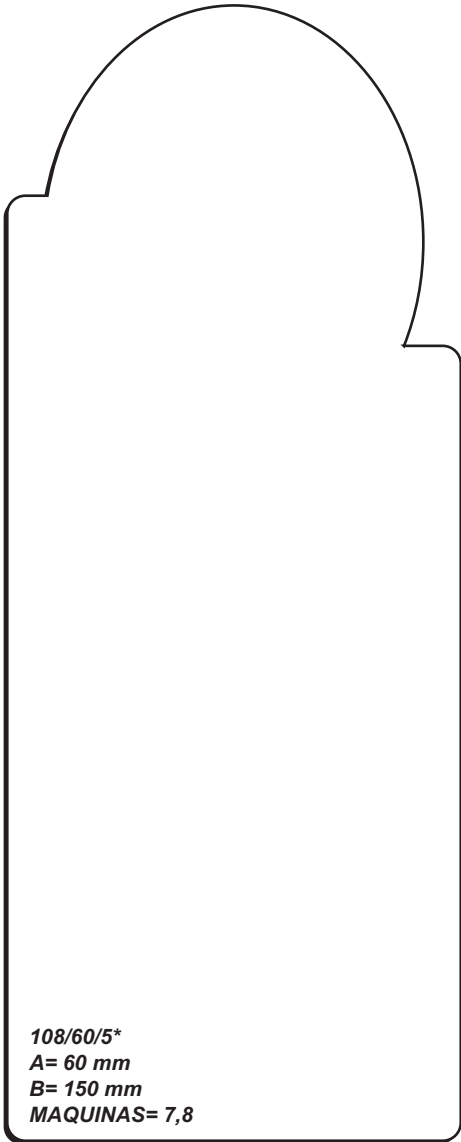



cintas y especialidades  
impresas s.a. de c.v.



108/78/2\*  
A= 119.7 mm  
B= 159.3 mm  
MAQUINAS= 7,8

108/63/3\*  
A= 196.8 mm  
B= 127 mm  
MAQUINAS= 7,8



cintas y especialidades  
impresas s.a. de c.v.

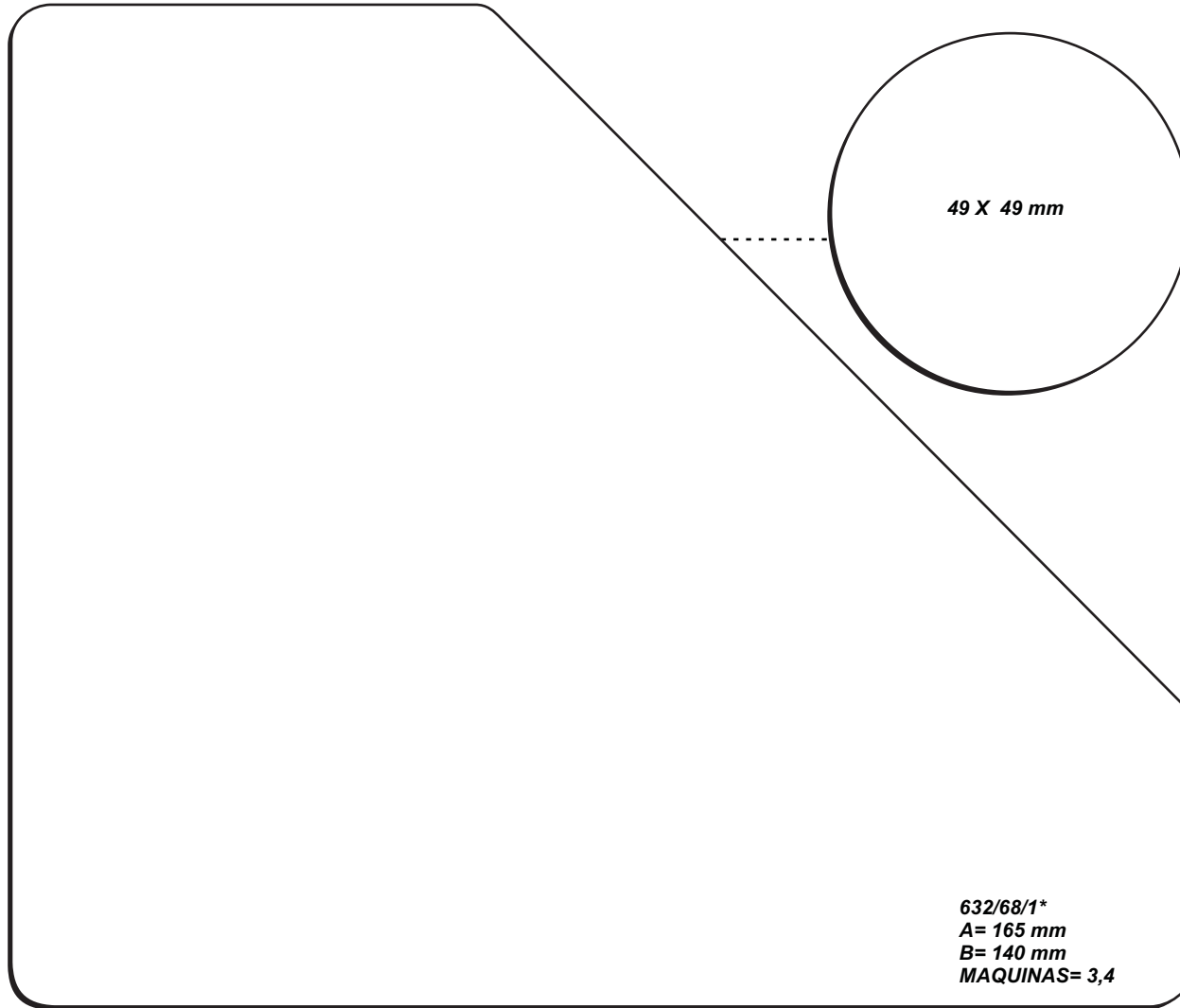



cintas y especialidades  
impresas s.a. de c.v.

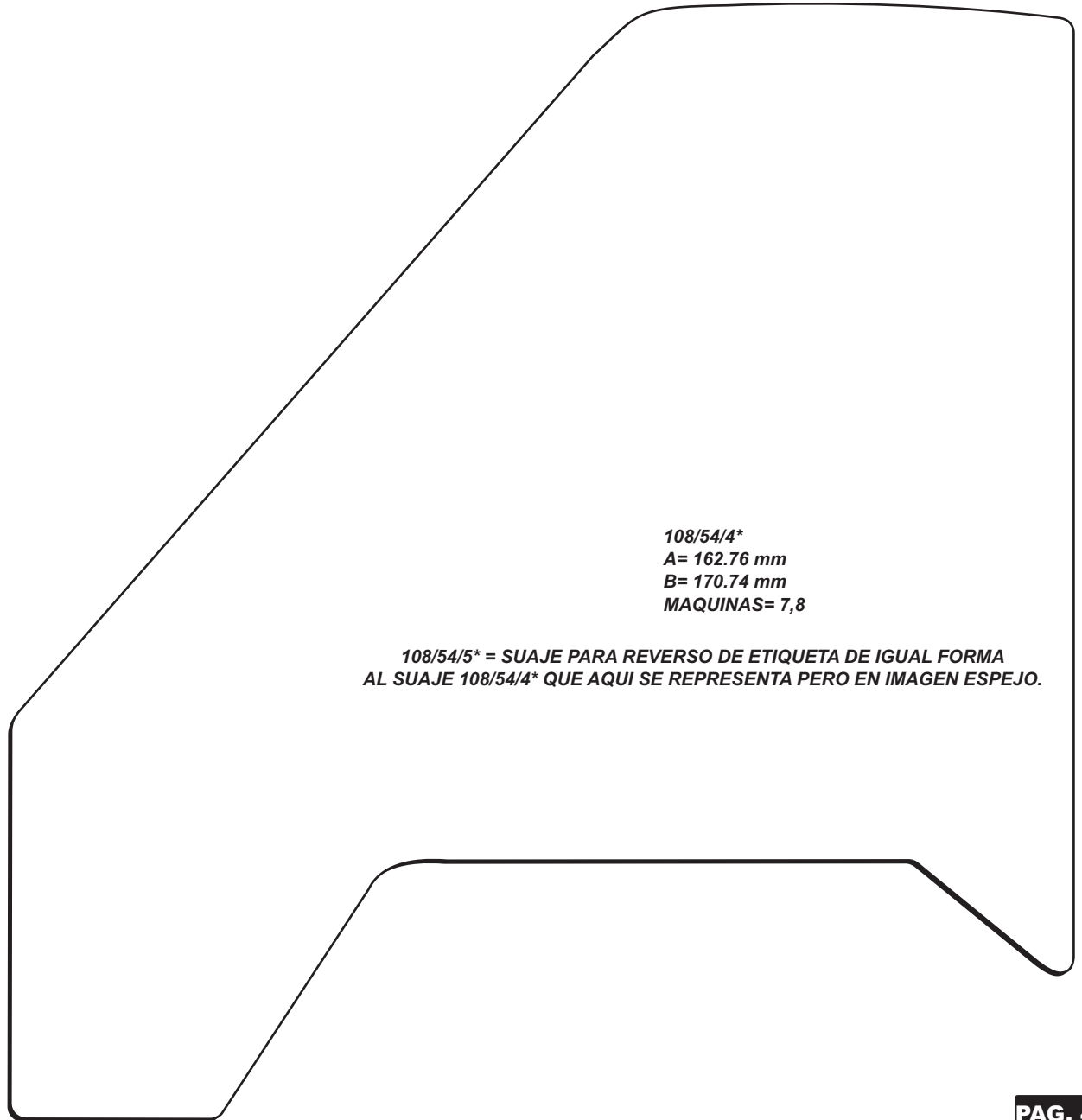
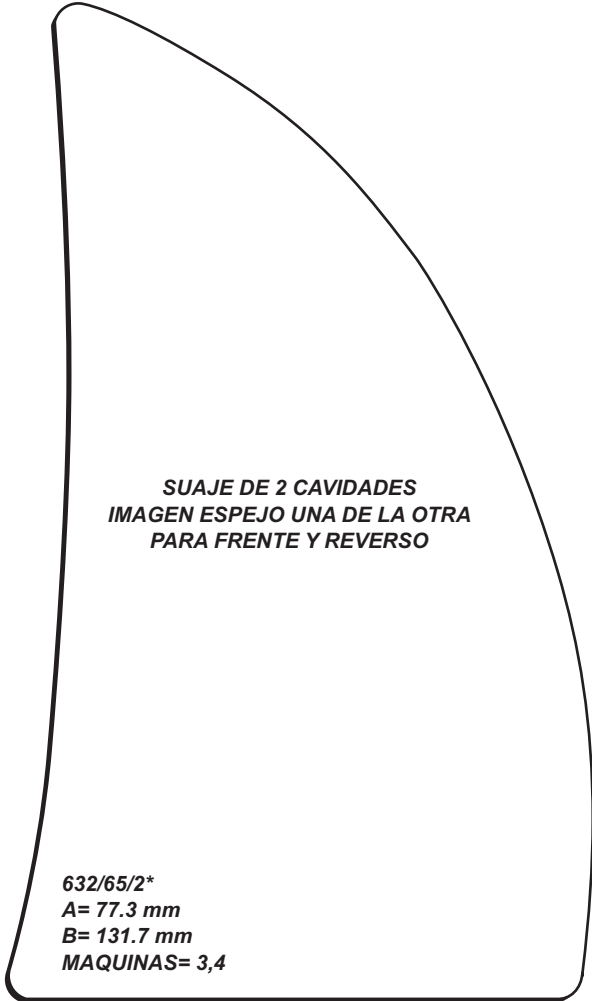



cintas y especialidades  
impresas s.a. de c.v.

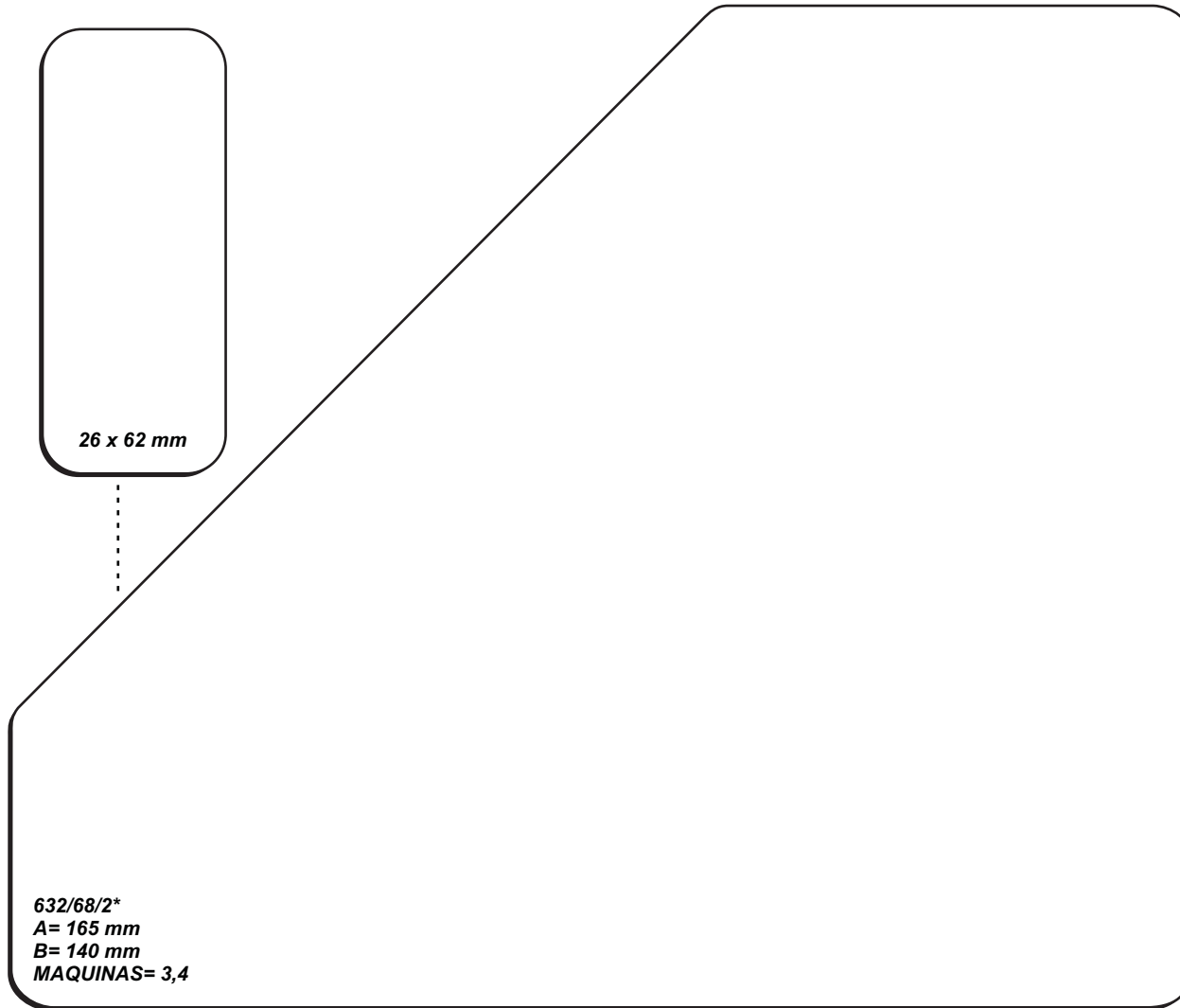



cintas y especialidades  
impresas s.a. de c.v.

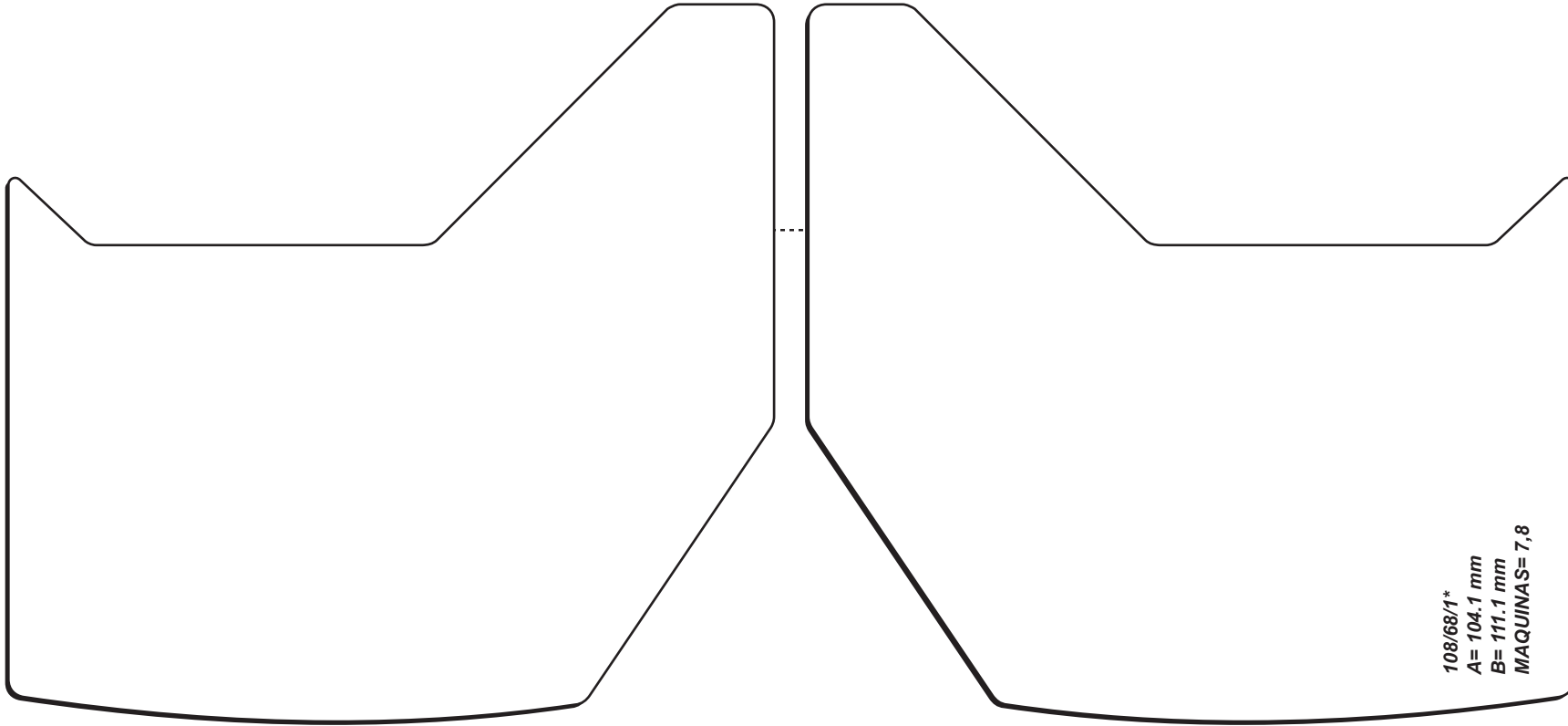

108/68/1\*  
A= 104.1 mm  
B= 111.1 mm  
MAQUINAS= 7,8



**SENTIDO DEL EMBOBINADO**



cintas y especialidades  
impresas s.a. de c.v.

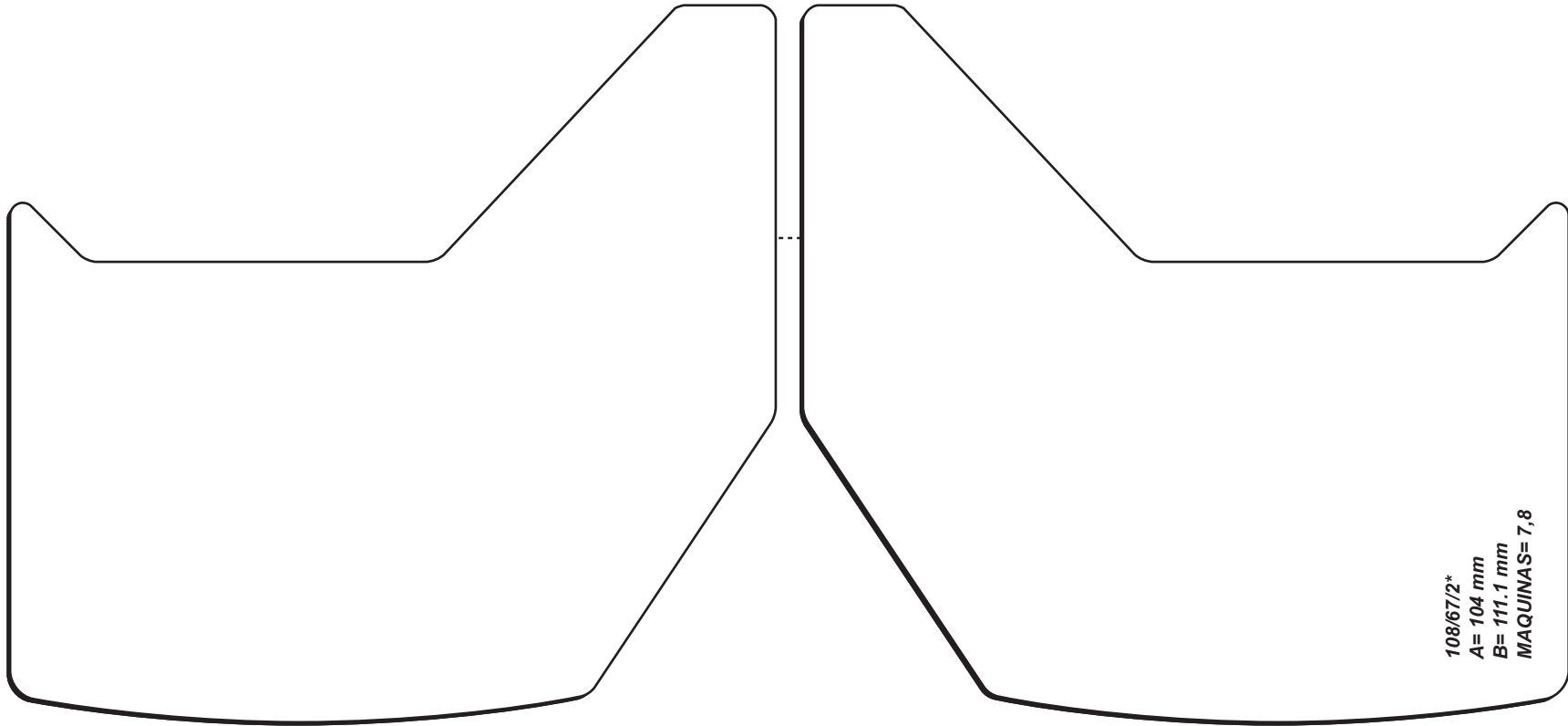

108/67/2\*  
A= 104 mm  
B= 111.1 mm  
MAQUINAS= 7,8





cintas y especialidades  
impresas s.a. de c.v.

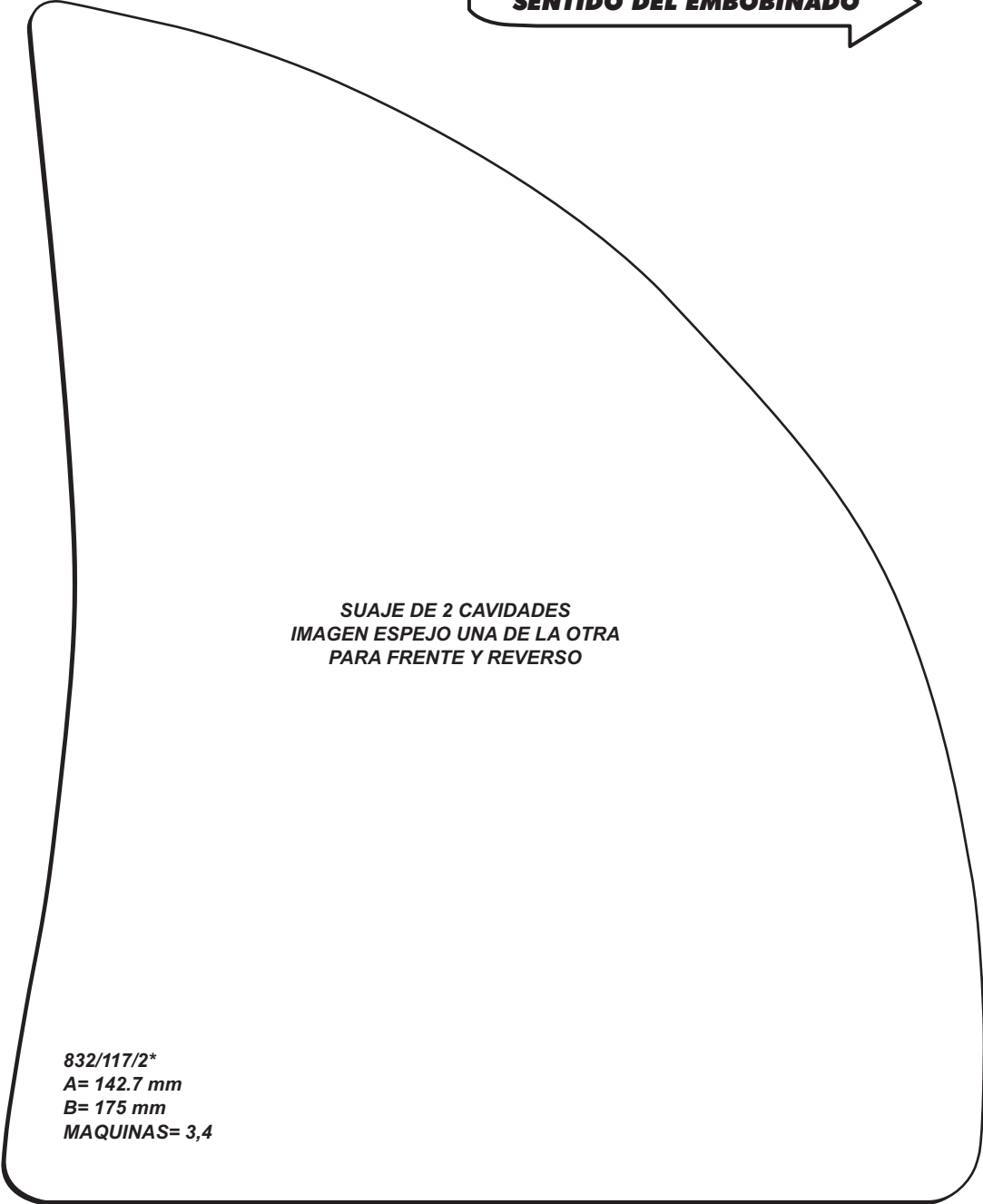



cintas y especialidades  
impresas s.a. de c.v.



632/127/1\*  
A= 314.1 mm  
B= 140 mm  
MAQUINAS= 3,4

*IMPRESO EN REDUCCION AL 75%*



cintas y especialidades  
impresas s.a. de c.v.



**SUAJES ESPECIALES**

**SUAJES DE CORTE COMPLETO Y CORTE ESPECIAL**

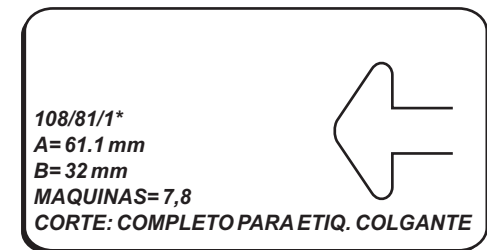
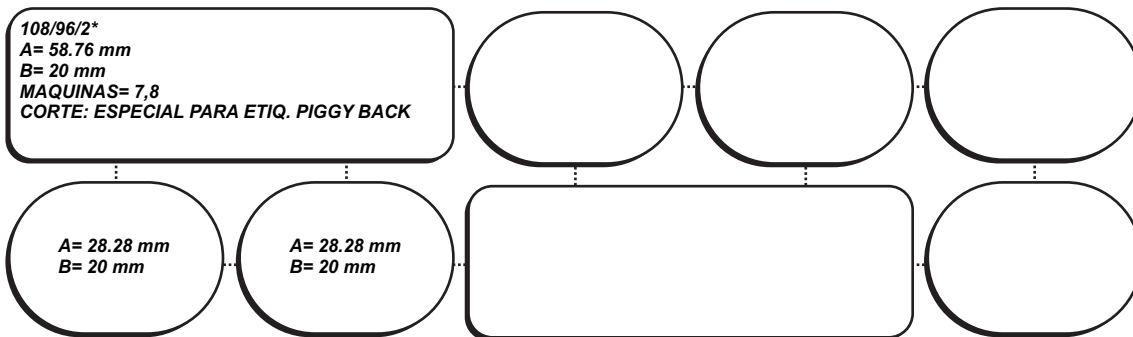
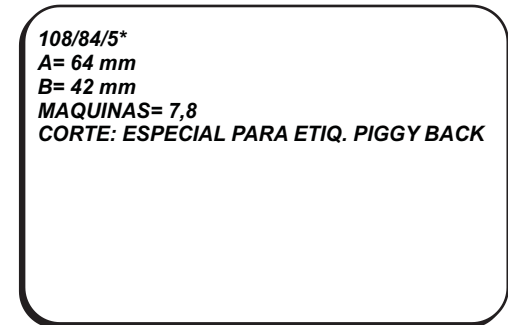
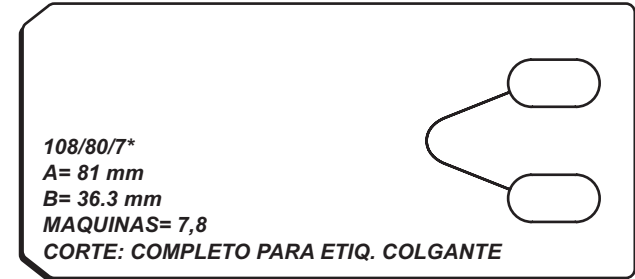
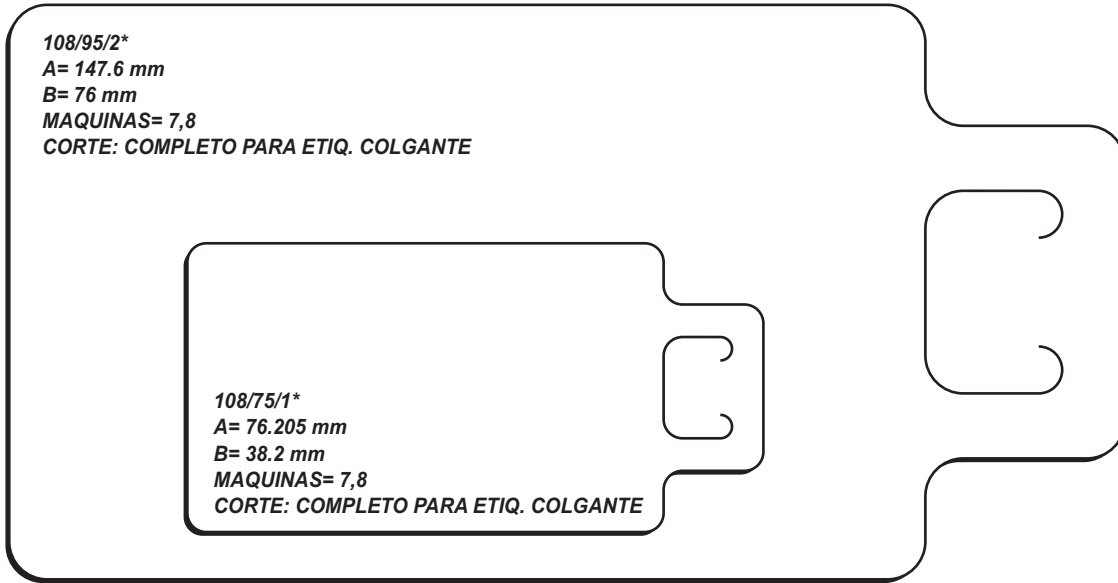



cintas y especialidades  
impresas s.a. de c.v.



**SUAJES ESPECIALES**

**SUAJES DE CORTE COMPLETO Y CORTE ESPECIAL**

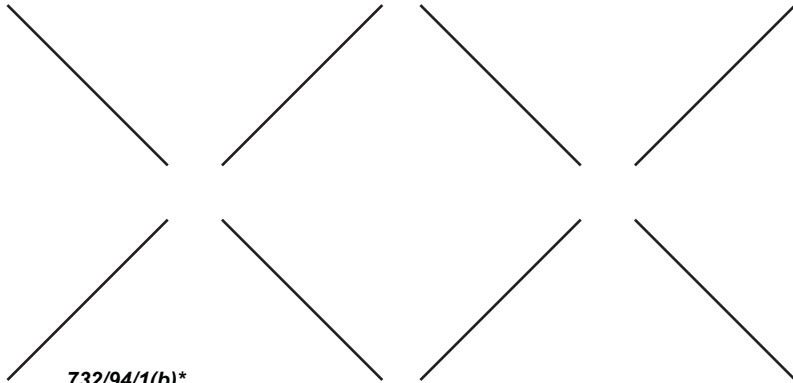

732/94/1(b)\*  
A= 104.23 mm  
B= 49.60 mm  
MAQUINAS= 3,4

632/76/2(b)\*  
A= 91 mm  
B= 32 mm  
MAQUINAS= 3,4

